

Versatile Laser Engine

1.0 rev 30 July 2024



User Guide

For model: VLE-700

©Andor Technology 2024

Section 1 - Safety and Warning Information

Caution



Please read this information first before using your product.

Use of controls or adjustments or performance of procedures other than those specified herein may result in hazardous radiation exposure.

Danger

The Software development kit (SDK) must be used as-is and not modified. Any changes are deliberate misuse and could increase the hazard level of the product, e.g. more lasers could be switched-on which would turn this Class 3B laser product into a Class 4 laser product, which also invalidates the laser safety labelling.

1. If the equipment is used in a manner not specified by Andor, the protection provided by the equipment may be impaired.
2. Warning: The BCU must be switched on when the Versatile Laser Engine is emitting, otherwise serious damage will occur to the BCU due to the power of the Versatile Laser Engine laser radiation. It is important that the BCU interlock connector is wired into the interlock system correctly as this will stop the Versatile Laser Engine emitting to protect the BCU.
3. Do not position this product so that it is difficult to operate the mains disconnecting device. See "[Emergency Mains Disconnection](#)" on page 43.
4. Before using the product, please follow and adhere to all warnings, and safety, manual handling, and operating instructions located either on the product, or in this manual.
5. If used in a Dragonfly system or with other products, refer to the Dragonfly hardware guide and the other products' hardware guides.
6. Keep this manual in a safe place for future reference.

-
7. Users must be authorised and trained personnel only; otherwise, this may result in personal injury, and/or equipment damage and impaired system performance.
 8. There are no user-serviceable parts inside the product and the enclosure must only be opened to perform the specified operations detailed in ["Operation" on page 43](#).
 9. IEC Technical Document IEC TR 60825-14 recommends the presence of a Laser Safety Officer (LSO); however, national guidelines should be referred to.
 10. Do not attempt to bypass any safety interlocks. They are provided to comply with the safety requirements of various regulatory agencies and must be employed to protect the operator.
 11. Protective earth is an integral part of the protection against electric shock in this product and is provided via the earth pin of the external power supply. Ensure that this is plugged into the building earth system via the mains socket. Do not tamper with any of the earthing measures.
 12. Any external AC/DC Power Supply used with this product must meet the requirements specified in ["Electrical Power Specifications" on page 66](#)
 13. No parts should be replaced by the customer, except for the mains cables or the fuse(s), which must be of the same type and rating as that supplied and as specified in ["Electrical Power Specifications" on page 66](#) or ["Fuse Replacement" on page 53](#), and certified in accordance with your region's safety regulations.
 14. Make sure all cables are located so that they will not be subject to damage, especially the mains cable.
 15. While running an experiment, keep room temperature as stable as possible.
 16. Performance of the system may be adversely affected by rapidly changing environmental conditions or operation outside of the operating conditions specified in ["Technical Specifications" on page 56](#)
 17. Ensure that adequate ventilation is provided for the product as specified in ["Environmental Specifications" on page 57](#).

-
18. This product is designed to only be used in an indoor environment. Do not use outdoors.
 19. Medical Diagnosis: This equipment has not been designed and manufactured for the medical diagnosis of patients.
 20. Electromagnetic Compatibility – Caution: This product was designed for and tested using the IEC/EN 61326-1 EMC standard for Class A emissions and a Basic immunity environment. Class A means that it is not designed for a domestic or residential environment, and Basic immunity refers to the fact that it is not designed for a typical industrial environment. This equipment is not intended for use in residential environments and may not provide adequate protection to radio reception in such environments.
 21. Electromagnetic Compatibility: As required by IEC/EN 61326-1, we must inform you that electromagnetic emissions in excess of that required by that EMC standard for the emissions class of this product can in theory occur due to its connection to other equipment.
 22. Electromagnetic Compatibility: This product has been designed and tested to perform successfully in a normal (basic) electromagnetic environment, e.g. a typical life science test laboratory, as per the EU EMC Directive. It is not designed to operate in a harsh electromagnetic environment, e.g. close to the following equipment: EMI/RFI generators, electrostatic field generators, electromagnetic or radioactive devices, plasma sources, arc welders, x-ray instruments, intense pulsed sources, or other similar sources of high energy fields whose emissions are not within the normal range expected under the EU EMC Directive.
 23. Ionising Radiation: Please note that this product is not designed to provide protection from ionising radiation. Any customer using this product in such an application should provide their own protection.
 24. This product is a precision scientific instrument containing fragile components. Always handle it with care.
 25. Heavy Product: Take care when lifting and follow the instructions regarding a ["Multi-Person Lift" on page 17](#).
 26. Optical Fibres: It is important that you read ["Working with Optical Fibres" on page 13](#).

-
27. Do not wet or spill liquids on the product, and do not store or place liquids on the product.
 28. If spillage occurs on the product, switch off power immediately, and wipe off with a dry, lint-free cloth.
 29. If any ingress of liquids has occurred or is suspected, unplug the mains cables, do not use.
 30. See "[General Cleaning & Decontamination Information](#)" on page 49
 31. Do not expose the product to open flames.
 32. Do not allow objects to fall on the product.

1.1 Laser Safety

Caution



Read and do not ignore!

Caution - Use of controls or adjustments or performance of procedures other than those specified herein may result in hazardous radiation exposure.

This product contains lasers, so you must be aware of the hazards associated with the use of the powerful laser radiation that can be emitted by this product.

- Laser radiation is emitted by this product when the Emission Indicator LEDs are illuminated.
- **WARNING:** As defined in IEC 60825-1, this product is Class 3B, which means that it is hazardous to the eyes. If the power approaches the Class 3B AEL and the radiation is concentrated sufficiently, it potentially could cause a fire.
- Extreme caution must thus be taken with the laser radiation emitted from this product.
- Be conscious of the path taken by the beam emitted by this product or any attached product.
- Do not expose any part of your body to the laser radiation emitted by this product or any attached product.
- Skin damage or deeper injury can be caused by lasers, but the eye is especially susceptible as laser light can be collimated into a narrow beam that can enter the eye and permanently damage the retina with life-changing consequences.
- The following labels summarise the same information and are located on the front panel of the main unit:



Figure 1: Versatile Laser Engine Class 3B Labels.

- The power indicated on this product would be very tame if it was a light bulb, but this should not deceive you as laser radiation is quite different.
- Laser radiation differs from ordinary light primarily because its optical power can be concentrated into a narrow, low-divergence beam, whereas, for example, a standard light bulb diffuses its light in all directions and thus spreads out its power. It's a bit like the difference between walking outside on a sunny day versus having the sun's light concentrated on your skin using a magnifying glass.
- Laser safety for this type of product is about reducing risk, rather than being able to eliminate it because access is usually required for the applications that it is typically purchased for, so it is not completely safe.
- Be aware that visible laser light is dangerous as well as invisible.
- Be aware that this product may emit invisible laser radiation outside the visible spectrum of 400 nm – 700 nm, which has the added danger that it cannot be seen. If you have such lasers, we advise that you purchase fluorescent cards that assist with observing the presence of the wavelength (s) of invisible laser radiation emitted by this product and that you use them safely.

-
- All lasers in this product are CW (Continuous Wave), are generated using laser diodes, are confined to a very narrow bandwidth and may have very narrow, low-divergence beams, depending on the application.
 - It is important to remember to beware reflections from objects such as tools or clips placed close to the laser beam emitted from the microscope objective.
 - One of the primary means of protection is protective housing, which as IEC 60825-1 says, “prevents human access to [hazardous] laser radiation (including errant laser radiation) except when human access is necessary for the performance of the function(s) of the product.”
 - As a user of a product that allows considerable access to hazardous laser radiation to enable it to be used in a wide number of different applications, it is important that you ask yourself how much access to the laser radiation do you need to perform the functions that you require and take any additional precautions that would be wise.
 - We strongly recommend that all facilities have an established system for the safe use of lasers as per their national regulations and occupational health and safety legislation. IEC TR 60285-14 Safety of laser products – Part 14: A user’s guide and the American National Standard for the Safe Use of Lasers (ANSI Z136.1) are standard references for best practice.
 - We also strongly recommend that all facilities have an occupational laser safety officer (LSO) as advised in the aforementioned guidelines, and that the LSO also has a copy of IEC 60285-1 Safety of laser products – Part 1: Equipment classification and requirements
 - You may consider purchasing laser safety goggles as part of your occupational laser safety protection measures.
 - Read the labels on the product and all of the following information on lasers and ensure that you know the power and wavelengths of the laser radiation emitted by your particular configuration of laser modules and understand the implications of this for you.
 - Ensure that the safety interlock system is in good condition and that you test it every day by opening and closing the various interlocked items and checking that the laser emission LEDs operate as expected.

-
- Ensure that all users of this product have read the laser safety material in this user guide and that they have received adequate training in the general safe use of laser products and specifically in the use of this product.

1.1.1 Laser Product Safety Standards

- This has been designed and manufactured to comply with the international laser product safety standard IEC 60825-1 and the U.S. CDRH Regulation 21CFR § 1040.10 to reduce risk as far as is reasonably practicable.
- In most instances our Customer Support Team install the system according to the same standards, but if there has been an agreement that you should install all or part of the laser product system, then you take responsibility to install this according to the same standards.

1.1.2 Laser Safety Protection Measures

The following protection measures are used in the product to reduce, but not eliminate, the risk of exposure to hazardous laser radiation in accordance with the international product laser safety standard IEC 60825-1 and U.S. CDRH Regulations 21 CFR 1040.10 and 1040.11

1.1.3 Emission LEDs

See "[System Power and Emission Enabled Indicator LEDs](#)" on page 29.

1.1.4 Key Switch

See "[Laser Power Key Switch](#)" on page 29.

1.1.5 Protective Housing

- Except at the identified laser apertures at the optical fibre output couplers, or at the ends of the attached optical fibres, or at the microscope stage, or other locations identified as a laser aperture in an attached laser product, the laser radiation within this product has been housed within an aluminium enclosure or inside optical fibre for your safety.
- Therefore, do not attempt to disassemble this product, including removing optical fibres, or try to gain access to its laser radiation, otherwise you endanger yourself and possibly others.

1.1.6 Safety Interlocks

- Safety interlocks are automatic devices, such as switches or sensors, that are used to prevent human access to laser radiation by stopping the laser product emitting (or in some instances reducing the power to a safe level, but not in this product).
- This product does not have safety interlocks built into the enclosure as it requires tools to gain access to the laser radiation within it.
- However, it is almost certain that external safety interlocks are attached to the Remote Interlock Connector of this product, e.g. for the eyepiece of a microscope.
- Understand how the interlock system works and do not disconnect or seek to defeat the interlocks as they are there for your protection.

1.1.7 Laser Safety Labelling

Another important protective measure is labelling, which is described in the following sections, and you must understand what these mean.

Laser Aperture Locations

- A laser aperture label indicates where laser radiation is emitted as a warning.
- If the point where laser is emitted from your system does not have such a label, then contact your occupational laser safety department and/or our Customer Support Team to arrange for a label to be affixed.
- The following label is located on each of the optical fibre output couplers on the unit and on the optical fibres provided with this product by Andor.
- These labels indicate that during installation laser radiation may be emitted from these locations when the optical fibres are disconnected.
- When properly installed, no laser radiation will be emitted from these locations during use.

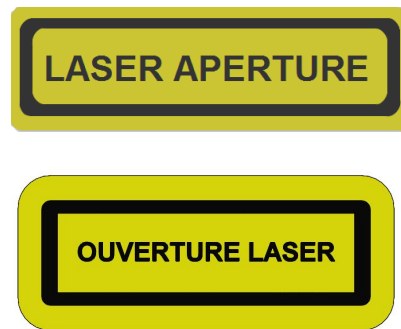

Figure 2: Standard laser aperture label.

- In the most common uses of this product, it will be connected to a larger system that includes a microscope. In such instances, the following label will be fitted beside the microscope objective, or, in the absence of an objective, the socket where the objective is attached.



Figure 3: Andor laser aperture label for a microscope stage.

- The system integrator **MUST** ensure that the final system's laser aperture is suitably labelled e.g. the microscope's objective is identified by a label on the microscope's stage top.

1.1.8 Access Panels

The following labels are located on panels that should only be opened by our Customer Support Team and which are not interlocked as they are tool-accessible:



Figure 4: Access panel labels.

1.1.9 Laser Product Classification Labels with Explanatory Text

- Copies of these labels can be found at the beginning of the Laser Safety Special Warnings section.
- The power values on these labels are intended as maximum values for classification purposes based on IEC 60825-1 Condition 3 (using a 7 mm limiting aperture to simulate the eye's pupil at a distance of 100 mm from the laser aperture) taking into account future versions of this product and possible failure scenarios. The wavelength range covers all of the possible wavelengths that can be installed in this unit.
- The actual values of power and wavelength for each of the modules in your version of the product can be found in the documentation accompanying your unit. See also "[Laser Specifications](#)" on page 62.
- Additional classification labels should be affixed to connected products that use laser radiation from this product. If these do not exist, then contact your occupational laser safety department and/or our customer support team to arrange for appropriate labels to be affixed.

1.1.10 CDRH Certification Label

The rear panel label includes the words “Complies with 21 CFR 1040.10 and 1040.11 except for conformance with IEC 60825-1 Ed. 3., as described in Laser Notice No. 56, dated May 8, 2019”. This means that it complies with the U.S. Federal Regulations for laser products as overseen by the Center for Devices and Radiological Health (CDRH), which is part of the Food and Drug Administration (FDA), by means of IEC 60825-1 Edition 3 as allowed by CDRH Laser Notice No. 56, except for some additional requirements as described in that Notice



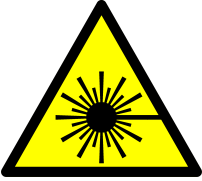





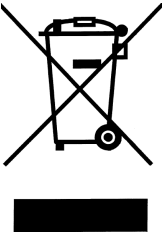

Figure 5: Rear panel label.

1.1.11 Working with Optical Fibres

- This was installed by our Customer Support Team. For your safety, only they should remove or inspect optical fibres.
- The laser radiation passing through fibres is potentially hazardous, so great care should be taken to avoid exposure to this radiation.
- Optical fibres can be easily damaged by bending or general mishandling, and are especially prone to damage by bending close to the connector.
- Ensure that the minimum bend diameter or radius is never exceeded when handled or coiled.
- The bend diameter is the diameter of the circle created by coiling the fibre, and the bend radius is half of this and created by the “corners” in your fibre layout.
- [The FOA state](#) that the minimum bend diameter is 40 times the outer diameter (OD) of the cable when under tension or 20 times when not under tension.

-
- The Versatile Laser Engine output fibres are all 3 mm OD, so the minimum bend diameter is 120 mm under tension. We recommend that you aim to have a bend diameter of 150 mm or preferably more.
 - The BCU output fibre is 5 mm OD, so the minimum bend diameter is 200 mm under tension. We recommend that you aim to have a bend diameter of 250 mm or preferably more.
 - The coupler is not designed to withstand pulling of the fibre. If the fibre is pulled the system performance could be compromised, the system may fail, or you may even be exposed to hazardous laser radiation.

1.2 Label Symbols

	Laser radiation hazard
	General warning symbol
	Crush hazard
	Certified for product safety in the United States and Canada
	Lift must be performed by more than one person (see Multi-person Lift)
	EU CE Mark by which we indicate that this product meets the requirements all the relevant EU Product Directives that require this mark, including the Low Voltage Directive for safety (as this product is manufactured in Northern Ireland, it does not require the UKCA Mark)
	EU WEEE (Waste Electrical and Electronic Equipment) Mark which indicates that this should not be disposed of in domestic waste but at a suitable recycling site
	China EPUP (Environmental Protection Use Period) Mark that indicates that this product is expected to last for 20 years approximately before ending-up in the waste and recycling system

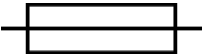
	Fuse symbol to denote that there is a fuse in the mains inlet connector that can be replaced with text adjacent to the symbol indicating its requirements (see also "Fuse Replacement" on page 53)
	D.C. voltage symbol

1.3 Multi-Person Lift

This product is heavy (see "[Mechanical Specifications](#)" on page 58) and therefore requires careful lifting and handling. Two people must lift it at all times, as shown in the warning label below, using the two handles highlighted below.



Figure 6: Multi-person lift required label.



Figure 7: Versatile Laser Engine handle positions on front and rear of unit highlighted.

1.4 Unpacking Information

Carefully unpack the unit and retain the packaging materials to transport or return equipment if required:

- If the equipment appears damaged in any way, return it to sales outlet in its original packaging.
- No responsibility for damage arising from the use of non-approved packaging will be accepted.
- Ensure all items and accessories specified at the time of ordering and as detailed on the packing list are present: if any items are missing, please contact your sales representative.

1.5 Revision History

Version	Released	Description
1.0	30 July 2024	Initial release

1.6 Updates to the Manual

Changes are periodically made to the product, and these will be incorporated into new editions of the manual. Please check for new releases of the manual at: andor.oxinst.com/downloads. If you find an issue in this manual, please contact your [customer support representative](#) with a description of the issue.

Section 2 - Introduction

This manual provides an overview of the Versatile Laser Engine. This product is intended for professional scientific research applications, especially bio-imaging, photo-stimulation and spectroscopy. The Versatile Laser Engine is a laser combiner system that utilises modern lasers. These are more efficient and smaller than previous generations. Thus, the Versatile Laser Engine is designed as a fully integrated instrument with only an a.c. mains cable required to provide electrical power and a USB or serial cable to provide command and control communications. A USB 2.0 interface is provided that allows communication with the Versatile Laser Engine and controls each laser channel via software. A primary shutter is also included to block any output when required. The Versatile Laser Engine also supports interfaces for direct control of lasers: TTL for fast switching.

The Versatile Laser Engine is constructed from a robust, rigid aluminium structure with the individual lasers mounted internally. Internal stabilization ensures that a reasonable variation in ambient temperature will not affect the system performance.

Inside the Versatile Laser Engine, the laser beams are individually focused onto a fibre output coupler. If the Versatile Laser Engine has a dual output configuration, a second fibre output coupler is serviced by an optical switch mechanism.

2.1 Technical Support

If you have any questions regarding the use of this equipment, please contact the representative from whom your system was purchased, or:

Europe

Oxford Instruments Andor
7 Millennium Way
Springvale Business Park
Belfast
BT12 7AL
Northern Ireland
Tel. +44 (0) 28 9023 7126

USA

Oxford Instruments America Inc.
300 Baker Avenue
Suite # 150
Concord
MA 01742
USA
Tel. +1 (860) 290-9211

Asia-Pacific

Oxford Instruments KK
Sumitomo Fudosan Osaki Twin Building East,
5-1-18 Kita-Shinagawa,
Shinagawa-ku,
Tokyo 141-0001,
Japan
Tel: +81(0)4510 3528

China

Oxford Instruments, China - Beijing
Floor 1, Building 17,
No.31 Xishiku Street, Xicheng Dist.
Beijing 100034
China
Tel: +86 (0)10 5884 7900

The latest contact details for your local representative can be found on our website andor.oxinst.com/support

2.2 Copyright and Protective Notices

The copyright in this document and the associated drawings are the property of Andor Technology Ltd. and all rights are reserved. This document and the associated drawings are issued on condition that they are not copied, reprinted or reproduced, nor their contents disclosed.

The publication of information in this documentation does not imply freedom from any patent or proprietary right of Andor Technology Ltd. or any third party.

2.3 Disclaimer

THE INFORMATION CONTAINED HEREIN IS PROVIDED "AS IS" WITHOUT WARRANTY, CONDITION OR REPRESENTATION OF ANY KIND, EITHER EXPRESS, IMPLIED, STATUTORY OR OTHERWISE, INCLUDING BUT NOT LIMITED TO, ANY WARRANTY OF MERCHANTABILITY, NON-INFRINGEMENT OR FITNESS FOR A PARTICULAR PURPOSE.

IN NO EVENT SHALL ANDOR BE LIABLE FOR ANY LOSS OR DAMAGE, WHETHER DIRECT, INDIRECT, SPECIAL, INCIDENTAL, CONSEQUENTIAL OR OTHERWISE HOWSOEVER CAUSED WHETHER ARISING IN CONTRACT TORT OR OTHERWISE, ARISING OUT OF OR IN CONNECTION WITH THE USE OF THE INFORMATION PROVIDED HEREIN.

PLEASE NOTE, AI TRANSLATIONS OF THIS USER MANUAL MAY RESULT IN INCORRECT INFORMATION. IN THE EVENT OF A CONFLICT WITH A FOREIGN LANGUAGE TRANSLATION, ANDOR'S ENGLISH TRANSLATION WILL PREVAIL.

2.4 Trademarks and Patent Information

Andor and Versatile Laser Engine are trademarks of Andor Technology Ltd. Andor Technology Ltd. is a wholly owned subsidiary of Oxford Instruments plc. All other marks are property of their owners.









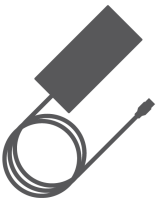

Manufacturers Information

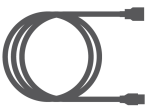
Oxford Instruments Andor

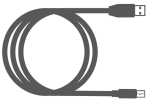
Andor Technology Ltd., Belfast, BT12 7AL, UK.

2.5 Supplied Components

The standard components supplied with the Versatile Laser Engine are shown below.

Description		Quantity	
	Versatile Laser Engine VLE Model as ordered	1	
Description	Quantity	Description	Quantity
 Power supply unit	1	 Beam conditioning unit (BCU)*	1
 Country specific power cord	1	 Triggering and Interlock cables (BNC)	-
 USB 3 cable	1	 Fibre optic cable (2 metre)	1
 RS-232 communication cable	1	 User Guide (electronic copy)	1
 Test report	1	 Keys for Versatile Laser Engine laser power switch	1

* BCU only supplied with system configurations including Dragonfly.

2.6 Optional Upgrades

Our Versatile Laser Engine (VLE) can be upgraded in the field to an HLE. The HLE User user guide (andor.oxinst.com/downloads/view/high-power-laser-engine-user-guide) should be referred to if your system has been upgraded from a VLE. Please see the performance sheet provided by your upgrade engineer for an overview of the lasers installed in the upgraded system. On installation the Safety and Warning labels will also be updated to match those of an HLE.

Please contact Andor support if there are any issues.

2.7 Product Overview

This section provides an overview of Versatile Laser Engine models.

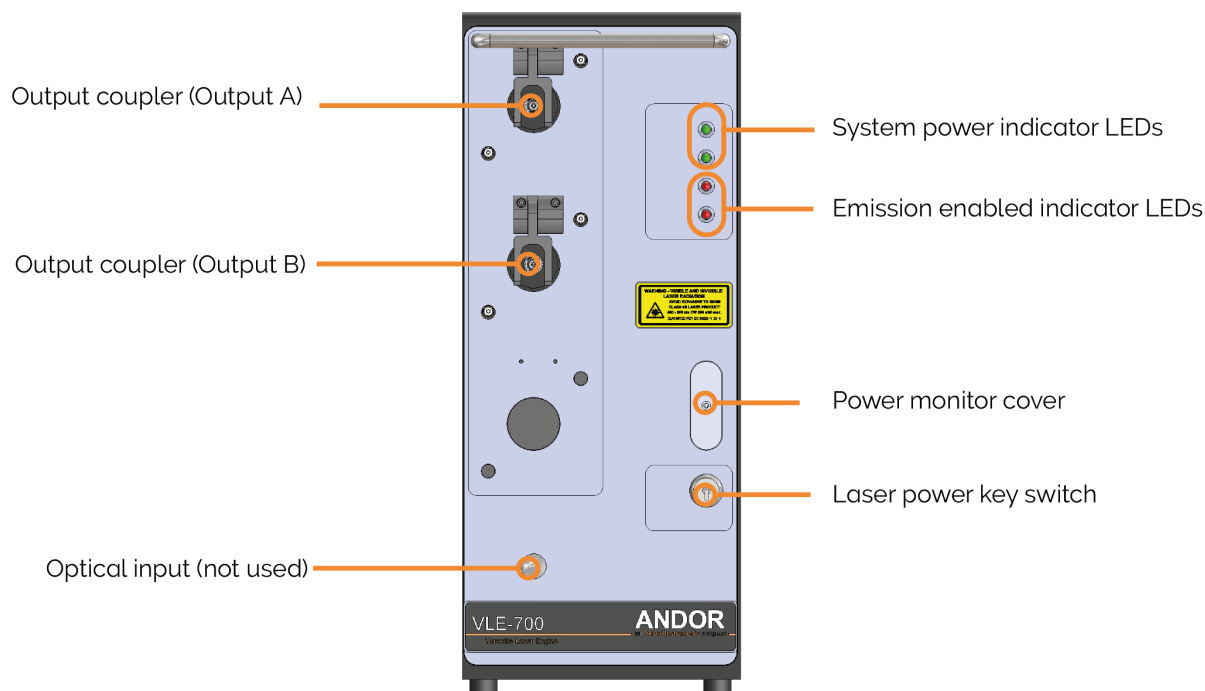

Figure 8: Versatile Laser Engine front panel.

2.7.1 Output Couplers

Laser is emitted from the unit via the output couplers. A single output is standard but dual output is available. They couple the internal laser outputs into MM fibre(s) attached depending on the requirements for the specific system configuration. A locking mechanism is provided for each of the outputs. This protects each fibre from disconnection from its output coupler.

Warning

Never remove the fibre lock when in operation. The cable should only be disconnected by qualified service personnel. A tool is required to open the locking mechanism once closed.

2.7.2 Laser Power Key Switch

The Laser Power Key Switch on the front panel of the Versatile Laser Engine disconnects electrical power to all the lasers via a control circuit if it is in the OFF position.

The key cannot be removed when the switch is in the ON position, but it can be removed when the switch is in the OFF position.

2.7.3 System Power and Emission Enabled Indicator LEDs

The upper green system power indicator LEDs light when the rear panel mains rocker switch is turned ON. The internal AC/DC power supply is receiving power from the mains power supply.

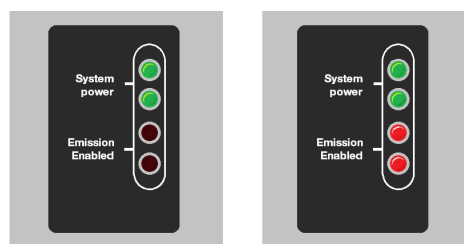

Figure 9: System power indicator LEDs and emission enabled indicator LEDs

The upper red LED is turned ON a few moments after the Laser Power Key Switch is turned on. The lower red LED is turned ON when the primary shutter is opened a few seconds after the laser power is turned on. This indicates that laser emission is possible and could be imminent. Both red LEDs are turned off if the interlock is open (See ["Remote Interlock" on page 31](#)). Note that there are two LEDs for redundancy, in case one fails. If one LED fails, notify Andor Service.

2.7.4 Power Monitor Cover

The power monitor is only accessible to service personnel and not accessible to users.

2.7.5 Optical Input (Blanked)

Not used on Versatile Laser Engine.

2.8 Rear Panel

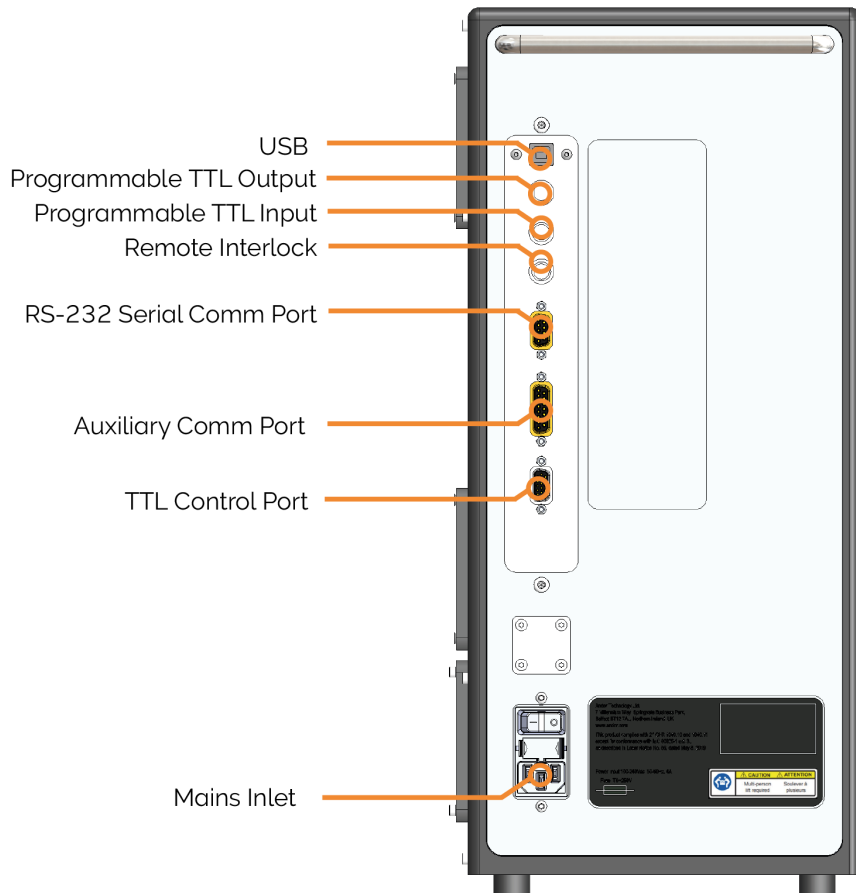

Figure 10: Versatile Laser Engine rear panel.

Table 1: Rear panel connector types.

Connection	Description
USB	USB 2.0 Standard Series B Receptacle
Programmable TTL Output	BNC socket
Programmable TTL Input	BNC socket
Remote Interlock	BNC socket
RS-232 Serial Comm Port	Standard 9-pin D-sub (DE-9) female socket
Auxiliary Comm Port	Reserved (not available to the user)
TTL Control Port	High-density 15-pin D-sub (DE-15) female socket
12 V DC Input	2 POS circular connector plug, female
Mains Inlet	Mains inlet connector type (IEC 60320-1 C14)

2.8.1 USB/RS-232

Either of the USB or the RS-232 connections may be used to communicate with the Versatile Laser Engine to control and monitor the lasers and other functions. The RS-232 uses the following settings: 19200 bps, 8 data bits, 1 stop bit, no parity, no hardware flow control. The USB connection uses the human interface device (HID) protocol and is automatically detected by compatible software programs. The USB can be connected to any USB port on the PC.

2.8.2 Programmable TTL Input/Output

Two BNC connectors are provided on the rear panel to allow the user to synchronize external equipment with the Versatile Laser Engine. Any common type of coaxial cable may be connected to the BNC connector including 50 Ω and 75 Ω types. Wire leads may also be used with an appropriate BNC coaxial to wire adapter. The Programmable TTL Input is by default configured to provide synchronization to an external camera fire signal. A high TTL level turns on any selected lasers and a low-level blanks the Versatile Laser Engine output. Synchronization is initiated by turning on the desired laser through the Versatile Laser Engine software interface, and then the selected lines will automatically be blanked when the TTL signal goes low and restored when the signal goes high. The TTL input is capable of driving lasers with less than one microsecond response time although the exact response time may be limited by the laser (see "[TTL Input/Output Specifications](#)" on page 68).

2.8.3 Remote Interlock

A BNC connector is provided so that the user can interlock the Versatile Laser Engine lasers using external switches or sensors present on microscopes, doors, etc. The contacts must be shorted for the lasers to operate. Please see "[Interlock Connections](#)" on page 38 for more information.

2.8.4 TTL Control Port

The HD15 D-sub connector provides the user with the capability of controlling the lasers via TTL control. The pinouts for this connector are provided below.

Table 2: TTL pin out information

Pin	Function
1	+5 V Output ¹
2	Dual output switch ²
3	Ground
4	TTL in 5 ²
5	TTL in 6 ²
6	TTL in 7 ²
7	Control Input ² (for triple output system)
8	TTL in 1 ²
9	TTL in 2 ²
10	TTL in 3 ²
11	TTL in 4 ²
12	Reserved
13	Reserved
14	Reserved
15	Reserved

1. 150 mA output maximum
2. TTL logic, (0-0.8 V low, 2.0-5.0 V high) 5.5 V max, 100 kΩ pull-down

2.8.5 Mains Inlet

A power switch is located above the power input socket (IEC 60320 C14 mains inlet) on the rear panel of the Versatile Laser Engine.

2.9 Beam Conditioning Unit (BCU)

Warning

The BCU must be switched on when the Versatile Laser Engine is emitting, otherwise serious damage will occur to the BCU due to the power of the Versatile Laser Engine laser radiation. It is important that the BCU interlock connector is wired to the interlock system correctly as this will stop the Versatile Laser Engine emitting to protect the BCU.

The BCU homogenizes the laser beam output from the laser engine multimode fibre to provide uniform illumination of the sample. It is coupled to the laser source through a multimode fibre with fibre optic couplings (FC/ APC). The output fibre (FC/APC) is of the armoured type and not removable and connects to the Versatile Laser Engine. The multimode output fibre has a square core cross section which is ideal for use with square format cameras e.g. iXon Ultra 897 or Zyla 4.2.

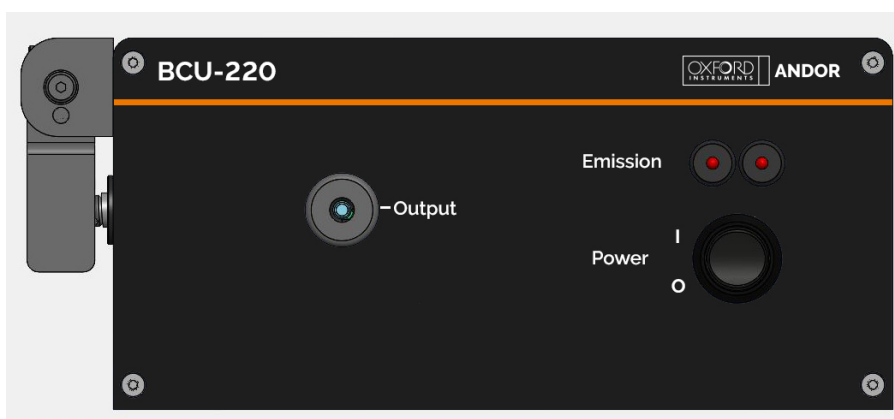

Figure 11: The beam conditioning unit (BCU).

2.9.1 Emission LEDs

Emission LEDs on the front panel of the BCU show the status of the unit. When these are lit, laser emission is possible. Please note there are two LEDs to provide redundancy for the laser emission status.

2.9.2 On/Off Switch

A toggle switch is located on the front panel of the BCU. This controls the power to the unit.

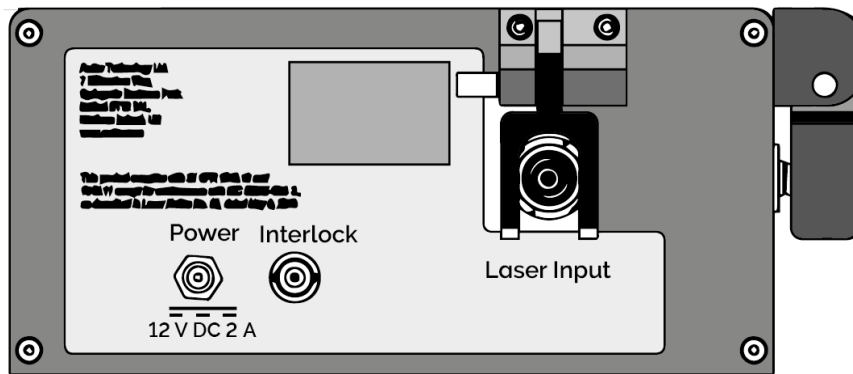

Figure 12: Rear panel of the BCU.

2.9.3 Power Input

A 2.1 mm input connector is used to provide DC power from the power supply unit to the BCU. Do not use any other power supply than the one supplied. See "[Power Supply Information](#)" on page 67.

2.9.4 Fibre Lock

A locking mechanism is provided on the rear panel of the BCU that closes over the input multimode fibre coming from the laser source. This fibre lock must be put in place at time of installation by the installer.

Warning

Never remove the fibre lock when in operation.

The cable should only be disconnected by qualified service personnel. A tool is required to open the locking mechanism once closed.

2.9.5 Fibre Input

A multimode fibre is provided to connect the laser source to the BCU. This connection is made to the fibre input connection on the rear panel of the BCU using the FC connector provided and locked in place with the fibre lock (see Fibre Lock description above).

2.10 System Overview

2.10.1 Power Connections

Power connections for the Versatile Laser Engine and the BCU are identified in the diagrams provided in "Rear Panel" on page 30 and "Rear panel of the BCU." on the previous page

As shown below, the BCU is connected via the PS-10 and the Versatile Laser Engine is connected from the mains slot via the IEC 60320 C14.

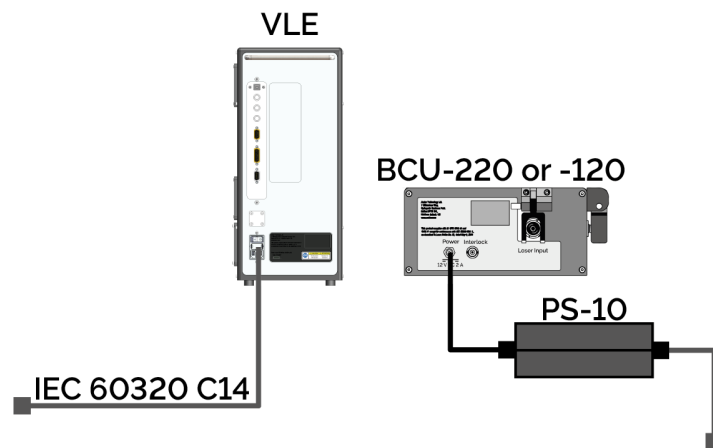

Figure 13: Power connections for Versatile Laser Engine and BCU configuration diagram.

Please see "Electrical Power Specifications" on page 66 and "Power Supply Information" on page 67 for further information.

2.10.2 Optical Connections

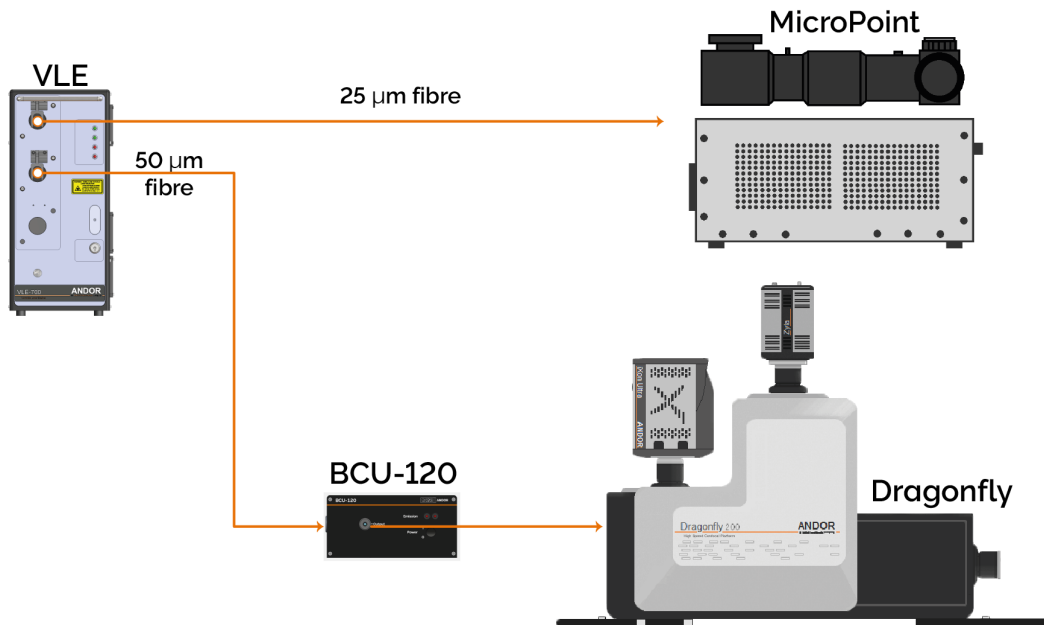

Figure 14: Overview of standard single VLE as part of an overall system, with two output couplers

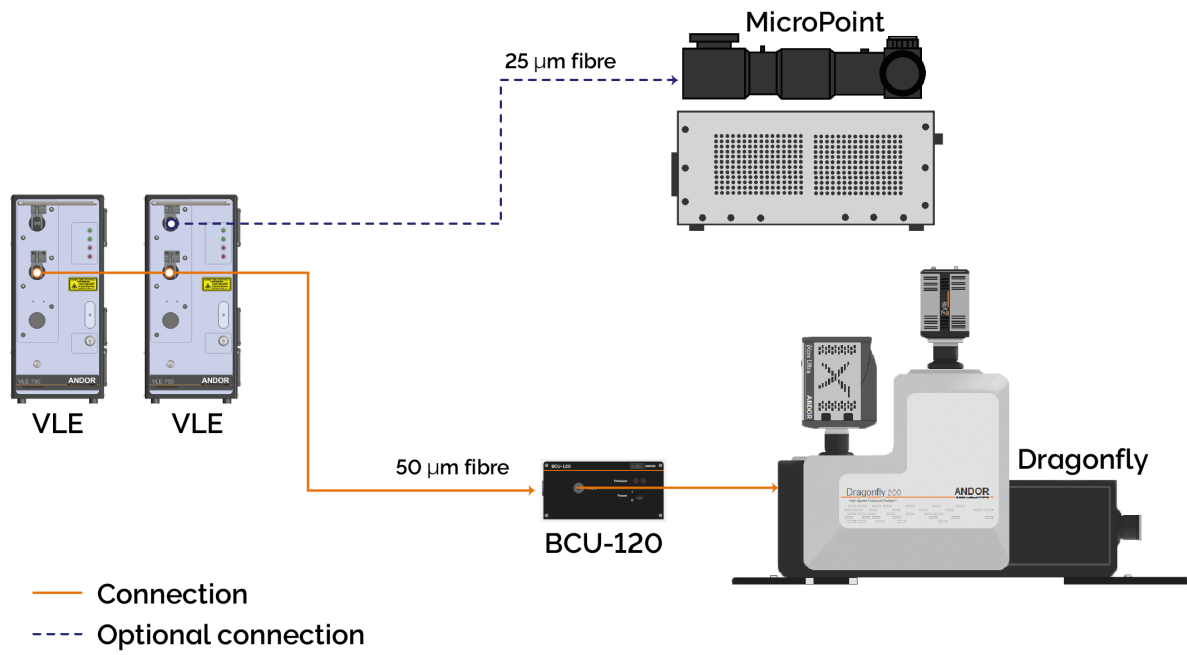

Figure 15: Overview of standard dual VLE as part of an overall system, with two output couplers.

2.10.3 Interlock Connections

A BNC connector is provided so that the user can interlock the Versatile Laser Engine lasers. The contacts must be shorted for the lasers to operate. When the interlock contacts are open, the primary shutter closes, and all the lasers are disabled.

When the interlock contacts are open, the primary shutter closes, and all the lasers are disabled.

1. When the microscope interlock is opened, the user must close the interlock and the laser configuration will be re-established.

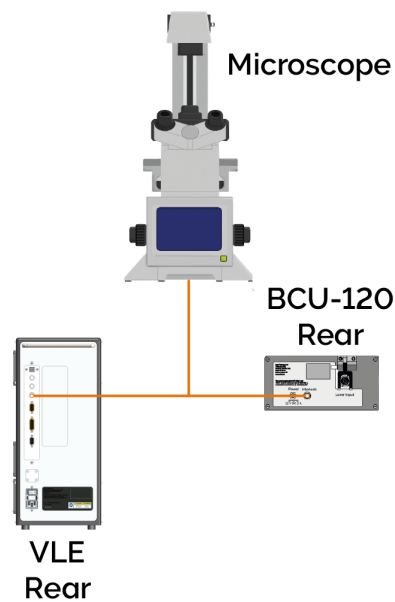

Figure 16: Interlock connection schematic for single Versatile Laser Engine.

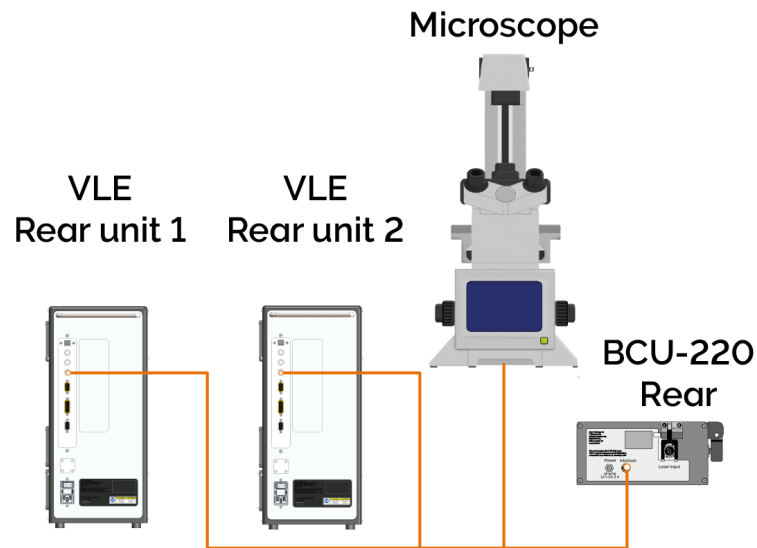

Figure 17: Interlock connection schematic for dual Versatile Laser Engine.

2.10.4 Laser Blanking Connections

These connections will be set up by your installation engineer. If you require further assistance please contact Andor customer support.

2.11 Lasers

Refer to "[Laser Specifications](#)" on page 62 and the laser safety sections in the preface of this manual for further information.

2.11.1 Primary Shutter

As part of the laser safety system, a primary shutter is incorporated that interrupts the output beam prior to the output coupler(s). This mechanism blocks the beam when the Interlock circuit is opened or when the key is in the off position. The primary shutter opens to allow the combined laser beam to be emitted when the interlock circuit is restored as described in "[Remote Interlock](#)" on page 31.

2.11.2 Laser Intensity Control

The laser output power is controlled from software via the USB or RS-232 serial communications interfaces.

2.11.3 Laser On/Off Control

Only 1 or 2 wavelengths are allowed by software to be on at any one time for any Versatile Laser Engine unit. In dual-Versatile Laser Engine configuration, this means that up to 4 lasers can be on.

The lasers can be turned on and off from software over the USB or RS-232 serial communications interfaces, and in addition can be quickly turned on and off via signals on the TTL Interfaces (Programmable TTL Input BNC and TTL Control Port D-sub connectors). The Programmable TTL Input BNC is used for Laser Blanking (see below), whereas the TTL Control Port has on/off control for individual lasers. The response times are shown in the table below.

Table 3: On/off speed restrictions for a range of laser types.

Laser	Description
Most VLE Lasers	$\leq 20 \mu\text{s}$ rise/fall times
LM-VLE-561-150	
LM-VLE-594-100	$\leq 10 \mu\text{s}$ rise/fall times
LM-VLE-561-100	

2.11.4 Laser Blanking

The standard configuration of the Versatile Laser Engine allows the lasers to be blanked (turned off) in response to a "Fire" signal from one or more cameras, or

other devices. This is to allow the lasers to only be on when required, esp. to avoid specimen damage or fluorophore bleaching.

Laser blanking uses the Programmable TTL Input BNC ("[Programmable TTL Input/Output](#)" on page 31), which functions as follows:

- The blanking input requires the camera "Fire" signal to be a TTL high when the camera is exposing and a TTL low during readout (not exposing).
- The Versatile Laser Engine will turn on all lasers enabled in software when the input is high and blank the laser outputs when the signal is low.
- The BNC input is internally pulled high in the absence of a signal input so that the Versatile Laser Engine will always be in expose mode if no camera fire signal is connected.

Section 3 - Installation

Warnings

The Versatile Laser Engine must be installed by an authorized installation engineer according to the information provided by Andor, any installation steps involving lasers must be performed by qualified personnel using pertinent laser safety protocols set and operation of other system components are described in their respective guides.

Please read and follow the instructions regarding a ["Multi-Person Liff" on page 17](#)

3.1 Location and Mounting

- Temperature and humidity must meet the specifications defined in ["Environmental Specifications" on page 57](#).
- Operational vibrations should be reduced as much as possible for stability of the imaging train.
- Power cabling and control cables should be routed to prevent accidents, damage and accidental unplugging while avoiding bend radii of less than 30 mm.
- Read ["Working with Optical Fibres" on page 13](#).

3.2 Ventilation

Do not cover equipment during operation- allow 100 mm space around the Versatile Laser Engine for ventilation.

3.3 Assembly

This product requires no assembly, as it must installed by an authorized service engineer

Section 4 - Operation

Warnings

The Versatile Laser Engine must be installed by an authorised installation engineer according to the information provided by Andor any installation steps involving lasers must be performed by qualified personnel using pertinent laser safety protocols setup and operation of other system components are described in their respective guides. If equipment is used in a manner not specified by Andor system distributors, the protection provided by the equipment may be impaired.

Read the user guides supplied with your system components prior to use.

4.1 Emergency Mains Disconnection

In case of emergency, the disconnecting point of the equipment is the mains power cord connected to the external power supply, or the mains socket switch.

Warning

Switch off the power at the mains socket and remove the mains lead from the external power supply.

4.2 Power Up Sequence

Once all system components are connected, it may be turned on as follows:

1. Turn **ON** the **BCU** using the **power switch** located at the front of the unit.
2. Turn **ON** the **rocker switch** on the rear panel of the **Versatile Laser Engine**. The green power indicators on the Versatile Laser Engine front panel will light.
3. Turn **ON** the **primary key switch** on the **Versatile Laser Engine** front panel. The red emission enabled indicators on the Versatile Laser Engine front panel light after a few seconds (Versatile Laser Engine initializing).
4. Allow the temperature within the Versatile Laser Engine to stabilize for 30 minutes for optimum stability. The lasers will generally, be operational within 1 minute.
5. Use the appropriate applications program on the control computer to configure the Versatile Laser Engine as required.

4.3 Power Down Sequence

In order to turn the system off, proceed as follows:

1. **Close the control software** (iQ/Fusion).
2. **Turn the laser power key switch to OFF** on the **Versatile Laser Engine** front panel. Leave the rocker switch on the rear panel of the Versatile Laser Engine turned ON for continued temperature control of the unit.
3. Only turn **OFF** the **BCU** using the **switch on the front** of the instrument, **when the Versatile Laser Engine is OFF**.
4. If the system is to be unused for a long period of time, turn **OFF** the **rocker switch** on the rear panel of the **Versatile Laser Engine**. Then **disconnect** the **BCU** and **Versatile Laser Engine from the power**.

4.4 Using the Versatile Laser Engine

Please refer to your software guide supplied with the control software, e.g. iQ, for a full description on the functionality available.

Pulse Width Modulation (PWM) Laser Control

Pulse Width Modulation (PWM) can be selectively enabled to support lower power levels and finer control than is possible by direct modulation alone. When active, PWM typically delivers power settings from 5% down to 0.01% in 0.01% increments and provides significant benefit to TIRF and localization microscopy using photo-activation.

Spinning disk microscopy will operate at higher power levels (typically $\geq 10\%$) and does not benefit from PWM. It is recommended to deactivate the PWM feature for spinning disk microscopy.

The PWM control on the Versatile Laser Engine applies a high frequency digital modulation to a laser in the Versatile Laser Engine. When this mode is activated, the laser is pulsed on and off so that the average laser power from the Versatile Laser Engine is reduced. Typically, the laser is pulsed on for 250 ns, and then turned off for a period of time that determines the intensity reduction.

Note
<p>PWM control functionality is software dependant. The software may automatically apply PWM control as appropriate, or it may be implemented when specifically activated by the user. Refer to your control software for further information.</p>

For example, the intensity of a laser in the Versatile Laser Engine may be controlled by a slider and/or a numeric control which sets the intensity from 0 to 100% (The appearance will vary depending on your control software). The Versatile Laser Engine commands let the laser intensity be set in 0.1% increments. When the PWM control is available an additional drop down is displayed beside the slider that lets the user select the PWM intensity value. The PWM drop down menu allows the user to select the order of magnitude of the PWM intensity control at the following intensity levels: 100%, 10%, 1% and 0.1% and 0.01% intensity.

This allows the user to select the order of magnitude of the maximum laser power. Power within each order of magnitude can then be precisely controlled- an example is shown below:

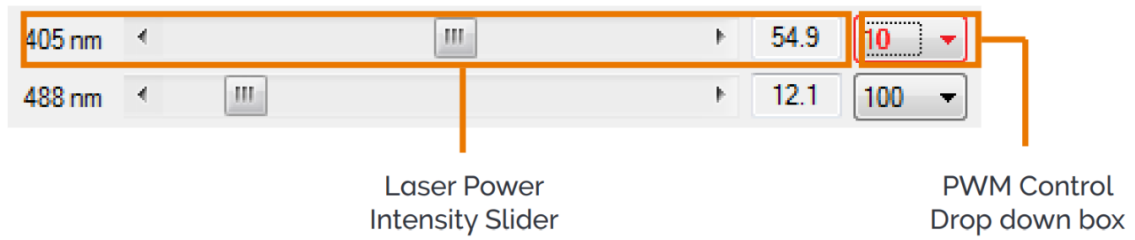

Figure 18: An example of control of laser intensity through the PWM function

Notes

Do not use PWM mode with Spinning Disk Confocal.

It is not recommended to reduce the PWM option to lower than 0.01%.

Section 5 - Maintenance

Warnings

The system should be powered down prior to user performing any maintenance procedures.

Do not use equipment that is damaged.

Contact your local Andor representative if there are any queries or issues with your Versatile Laser Engine.

5.1 General Cleaning & Decontamination Information

- The product body can be cleaned with a soft cloth and dampened by water or glass cleaner.
- Never spray liquids directly on the product; apply cleaning solution to the cloth, then wipe the product body with the dampened cloth.
- Do not use abrasive or other detergents to clean the product.
- Decontamination: In the event any product must be returned the customer must complete a decontamination form to declare the equipment is contamination free and safe for Andor employees to work on:
andor.oxinst.com/rma

5.2 Cleaning or Replacing the Air Filter

Check the air filter on the Versatile Laser Engine monthly to ensure that it is clean. The air filter can be removed as follows:

1. Snap off the cover to access the filter.
2. The filter is reusable- it can be easily cleaned by vacuuming or washing with a mild detergent.
3. Ensure the filter is dry before reinstalling it in the Versatile Laser Engine.
4. Replace the cover.

5.3 Regular Checks

The state of the product should be checked regularly, especially the integrity of the enclosure, the optical fibres and the mains cable.

On a Daily Basis:

- Visually inspect the system.
- Perform any maintenance activities suggested by the microscope and camera manufacturer(s).

On a Weekly Basis:

- Ensure that all power cables are firmly in place.
- Check the optical cables and connections to ensure that the locks are in place and no damage has occurred to the optical fibres connecting the various elements of the system.

5.4 Annual Electrical Safety Checks

- It is advisable to check the integrity of the insulation and protective earth of the product on an annual basis, e.g. U.K. PAT testing. However over time the repetition of dielectric strength tests can damage safety insulation.
- Do not use equipment that is damaged.

5.5 Fuse Replacement

A fuse is located in the power inlet on the rear of the Versatile Laser Engine. If this requires replacement, replace with fuse of same type and rating: T4H250V 5 x 20 mm, 250 V 4 A slow blow/time delay Littelfuse 0215004, MXP or equivalent.

5.6 Troubleshooting

Fault	Possible Cause	Action
Green power LEDs do not light	Unit not receiving power	Check the power cables are connected and power switched on. Check that fuse is not blown. Replace fuse if necessary, with same type and rating.
No laser output	Interlock contacts open	All laser safety interlocks must be closed for lasers to operate. Check the interlock system is connected. Confirm that Red LED Emission indicators light. The lower red LED is ON when the Laser Power Key Switch is turned on. The upper red LED is ON when the Primary Shutter is open a few seconds after the laser power is turned on.

Appendix

The following sections contain information on product specifications, including technical, environmental, mechanical and electrical specifications. In addition, detailed mechanical drawings are presented.

Appendix A: Technical Specifications

Model Specifications	Versatile Laser Engine
Max number of lasers	7
Output mode	Multimode only
Wavelength range (nm)	405-785
Multiport switch outputs	Up to 2
Multiport switch time (ms)	<7
Blank/TTL modulation (diode) MHz	1
Blank/TTL modulation (Fibre) kHz	0.1
Blank/TTL modulation (OPSL) kHz	50
Computer control interface	RS-232 or USB 2.0
TTL control interface	Ext TTL only (no analogue)
Non-linearity (% Full scale)	<5%

Environmental Specifications

Location to be used	Indoor use only
Operating temperature	18°C to 28°C ambient
Storage temperature	-20°C to 50°C
Operating relative humidity	<70% (non-condensing)
Pollution degree	Pollution degree 2. Normally only non-conductive pollution occurs. Occasionally, however, a temporary conductivity caused by condensation must be expected.
Cooling vent clearance	Do not cover during operation. Allow 100 mm clearance at air vents.

Mechanical Specifications

Versatile Laser Engine	
Weight (Versatile Laser Engine unit only)	30 kg
Weight (External Power Supply)	1 kg
Dimensions	See Mechanical Drawings

Appendix B: Mechanical Drawings

VLE Mechanical Drawings

VLE dimensions: mm

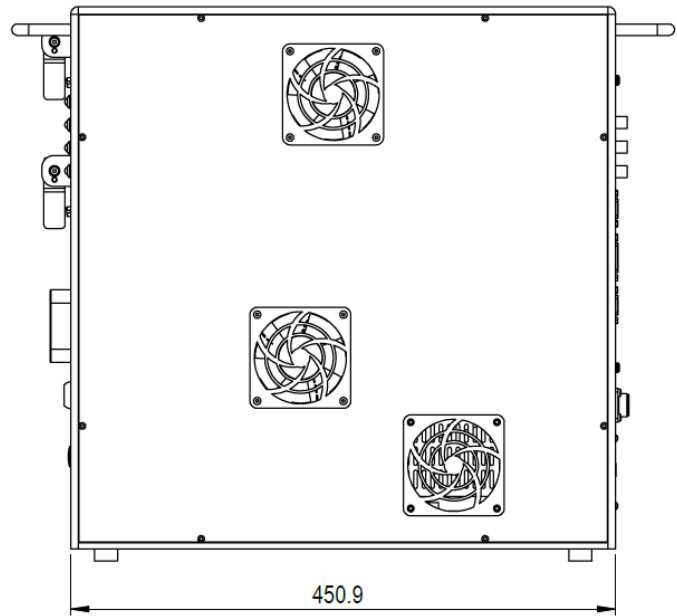
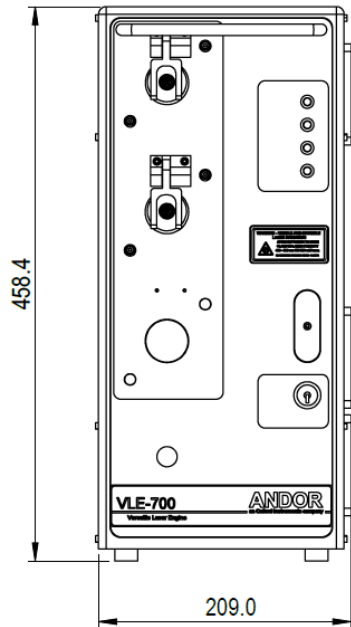

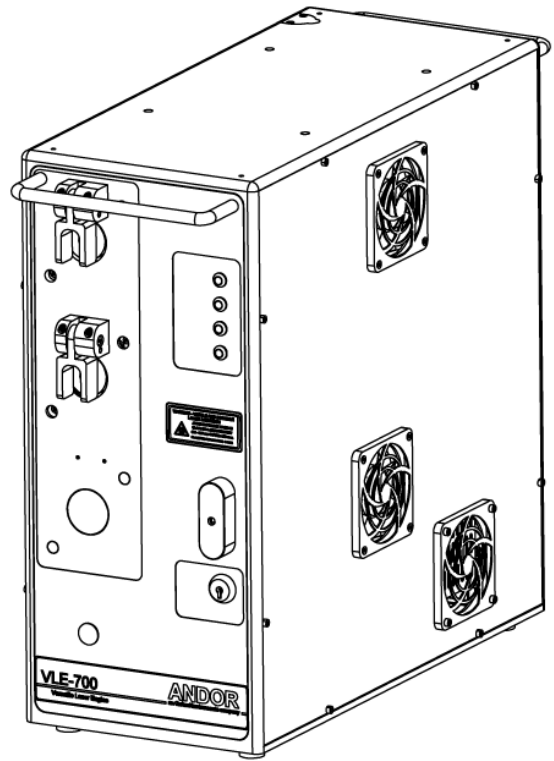
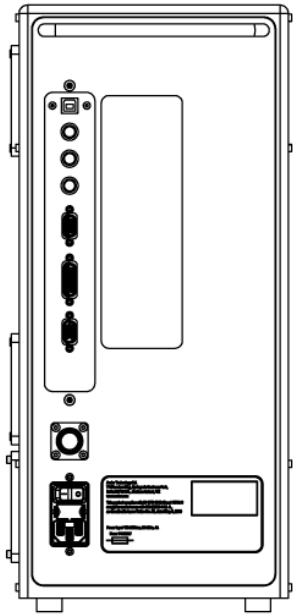

BCU Mechanical Drawings

BCU dimensions: mm

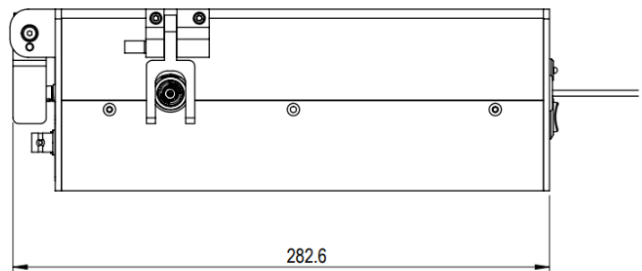
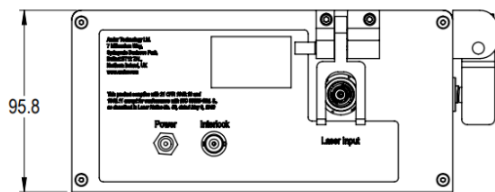
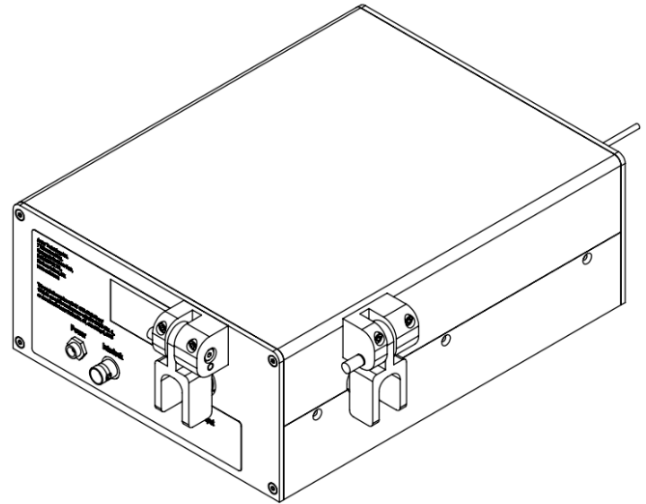
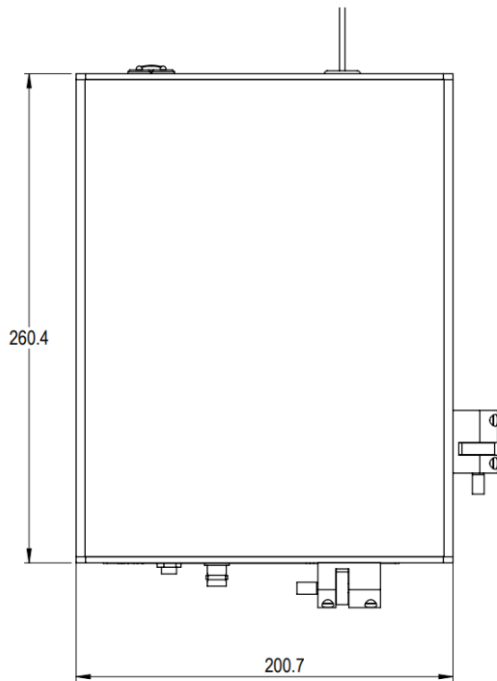

Appendix C: Laser Specifications

Output Specifications		
Single VLE maximum output power	≤ 500 mW	Maximum of 2 lasers can be turned on at once under Fusion control. This is an IEC 60825-1 classification value and is far greater than in normal use. See the 'specifications for the individual lasers on the following pages and more information in
Dual-VLE BCU maximum output power	≤ 500 mW	Maximum of 4 lasers can be turned on at once under Fusion control. See previous note.
Operating wavelength range	400 to 800 nm	
Output Fibre		
Fibre type	Multimode (MM)	
Connector type	FC/APC	
Beam Divergence		
Beam divergence at internal module output	0.5-3 mrad (full angle)	The divergence depends on the properties of the laser inside the VLE.
Beam divergence at VLE coupler output	0.025-0.13 NA (3-15 degrees full angle)	
Beam divergence at VLE 50 μ m fibre output	≤ 0.12 NA (14 degrees full angle)	
Beam divergence at VLE 25 μ m fibre output	≤ 0.10 NA (12 degrees full angle)	
Beam divergence at BCU fibre output	≤ 0.14 NA (16 degrees full angle)	
Beam Diameter		
Beam diameter at internal module output	0.3 - 3 mm	The diameter depends on the properties of the laser inside the VLE
Beam diameter at VLE coupler output	20 - 100 μ m	
Beam diameter at VLE 50 μ m fibre output	50 μ m	
Beam diameter at VLE 25 μ m fibre output	25 μ m	
Beam size at BCU fibre output	175 x 175 μ m	Fibre has square profile, so beam is square at fibre output

Appendix D: VLE Laser Output Power Specifications

Order code	Laser wavelength, nm	Power at internal module output, mW		Power at coupler output, mW		Power at 50 μm , 0.12 NA, fibre output, mW	
		Typical	Maximum	Typical	Maximum	Typical	Maximum
LM-405-488-DUAL-VLE	405	200	215	170	190	150	165
LM-445-515-DUAL-VLE	448	215	240	190	210	160	175
LM-405-488-DUAL-VLE	488	160	180	140	155	120	130
LM-445-515-DUAL-VLE	515	155	170	140	155	120	130
LM-561-50-VLE or LM-561-50-VLESLT3	561	45	55	40	45	35	45
LM-561-100-VLE or LM-561-100-VLESLT3	561	95	105	85	95	75	85
LM-561-150SL-VLE or LM-561-150SL-VLESLT3	561	140	160	130	140	110	120
LM-594-100SL-VLE LM-640-730-DUAL-VLE or LM-640-VLE	594 638	100 195	110 215	90 165	100 185	80 140	90 155
LM-685-780-DUAL-VLE or LM-685-780-DUAL-VLE-SLT2	685	125	140	105	120	75	85

Order code	Laser wavelength, nm	Power at internal module output, mW		Power at coupler output, mW		Power at 50 μm , 0.12 NA, fibre output, mW	
		Typical	Maximum	Typical	Maximum	Typical	Maximum
LM-640-730-DUAL-VLE	730	185	200	135	150	95	105
LM-685-780-DUAL-VLE or LM-685-780-DUAL-VLE-SLT2	780	210	230	180	195	125	140

Wavelength tolerances: 405 +5/-7 nm; 445 +7/-3 nm; 561 & 594 \pm 2 nm; 685 & 780 \pm 3 nm; 488, 515, 638, 730 \pm 5 nm;

Appendix E: BCU Laser Output Power Specifications

Order code	Laser wavelength, nm	Power at fibre output for BCU-120 and BCU-220, mW	
		Typical	Maximum
LM-405-488-DUAL-VLE	405	90	100
LM-445-515-DUAL-VLE	448	100	110
LM-405-488-DUAL-VLE	488	80	90
LM-445-515-DUAL-VLE	515	75	85
LM-561-50-VLE or LM-561-50-VLESLT3 LM-561-100SL-VLE or LM-561-100SL-VLESLT3	561	25	30
LM-561-150SL-VLE or LM-561-150SL-VLESLT3		55	60
LM-561-150SL-VLE or LM-561-150SL-VLESLT3		80	85
LM-594-100SL-VLE	594	60	65
LM-640-730-DUAL-VLE or LM-640-VLE	638	100	110
LM-685-780-DUAL-VLE or LM-685-780-DUAL-VLE-SLT2	685	45	55
LM-640-730-DUAL-VLE	730	65	75
LM-685-780-DUAL-VLE or LM-685-780-DUAL-VLE-SLT2	780	80	90

Wavelength tolerances: 405 +5/-7 nm; 445 +7/-3 nm; 561 & 594 ±2 nm; 685 & 780 ±3 nm; 488, 515, 638, 730 ±5 nm;

Appendix F: Electrical Power Specifications

	Versatile Laser Engine
Mains input for main VLE unit	100 – 240 VAC, 50 – 60 Hz
Current rating for main VLE unit*	3 A
Mains overvoltage category	CAT II An overvoltage category of CAT II means that the equipment is designed to cope with transient voltages above the rated supply that would be experienced by any product connected to a standard single-phase mains socket in a building.
*Current rating includes what VLE main unit is capable of for future purposes. This will therefore give a power consumption figure which is greater than what the current laser configurations will consume.	

	Power Consumption, W
VLE with 2 diode lasers on	45 Typ./60 Max.
VLE chassis	
VLE key switch off (heaters stay on)	23 Typ.
VLE on (fans off), lasers off	25 Typ.
VLE on (fans on), lasers of	44 Typ.
VLE lasers/modules	
LM-405-488-DUAL-VLE	6 Typ.
LM-445-515-DUAL-VLE	10 Typ.
LM-640-730-DUAL-VLE	8 Typ.
LM-640-VLE	3 Typ.
LM-685-780-DUAL-VLE	7 Typ.
LM-561-150SL-VLE, LM-561-100SL-VLE or LM-594-100SL-VLE	8 Typ./13 Max.
BCU Power Consumption	BCU + External Power Supply: 1 W typical BCU Only: 1.5 W typical

Power Supply Information

BCU External AC/DC Power Supply Requirements

	BCU
Supplied EPS	PS-10
Mains Input	100 – 240 VAC, 50 – 60 Hz
Low Voltage Supply Input	12 V
Low Voltage Supply Current	2.08 A
Low Voltage Supply Cable Plug	Standard DC coaxial connector with 2.1 mm inner diameter and 5.5 mm outer diameter (a.k.a. P1J)
Low Voltage Supply Cable Plug Insertion View	
Low Voltage Supply Product Socket	CUI Devices, PJ-005A, power barrel connector jack 2.00 mm ID (0.079"), 5.50 mm OD (0.217") panel mount, through hole
Low Voltage Supply Product Socket Insertion view	
Ripple	100 mV peak-to-peak
Safety	Certified to IEC 62368-1 in accordance with local safety regulations and meets the reinforced insulation from mains requirement of IEC 61010-1
Environmental	Ensure that the EPS meets the environmental specification of the overall product

Appendix G: TTL Input/Output Specifications

TTL Signal	Description
Input	Low: 0-0.8 V High: 2.0-5.0 V 100 k Ω internal pull up resistor to 5 V so that the lasers will operate when no cable is attached.
Output	+/-4 mA up to 5 V

Appendix H: Other Information

Terms and Conditions of Sale and Warranty Information

The terms and conditions of sale, including warranty conditions, will have been made available during the ordering process. The current version for the US is [available here](#), for all other regions (except Japan) please [click here](#).

EU/UK REACH Regulation Statement

Andor's EU/UK REACH Regulation statement is available at the [following link](#).

Waste Electronic and Electrical Equipment

The company's statement on the disposal of WEEE can be found in the Terms and Conditions.



Appendix I: China RoHS Hazardous Substances Declaration

Hazardous Substance: 有害物质						
Component Name 部件名称	Lead (Pb) 铅	Mercury (Hg) 汞	Cadmium (Cd) 镉	Chromium VI Compounds (Cr6+)	Polybrominated Biphenyls (PBB)	Diphenyl Ethers (PBDE)
Printed Circuit Board Assemblies (Surface-mount Resistors and Capacitors, and Brass Connectors) 电路板组件 (表面贴装电阻器和电容器, 以及黄铜连接器)	X	○	○	○	○	○
Hex Stand-offs (see image in table below) 六角隔撑	X	○	○	○	○	○
Screw Locks (see image in table below) 螺丝锁定	X	○	○	○	○	○
Fibre receptacle cap 光纤头保护帽	X	○	○	○	○	○
Key Switch 钥匙开关	X	○	○	○	○	○
Optical Fibre 50 µm FC/FC 50 µm芯径FC/FC接口光纤	X	○	○	○	○	○
Optical Fibre 175 µm 175 µm芯径光纤	X	○	○	○	○	○
PS-10 External Power Supply (Mean Well GST25A12-P1J) PS-10 外接电源 (Mean Well GST25A12-P1J)	X	○	○	○	○	○
All other parts 其余配件	○	○	○	○	○	○

This table was developed according to the provisions of SJ/T 11364

本表格依据SJ/T 11364 的规定编制

O - The content of such a hazardous substance in all homogeneous materials of such a component is below the limit required by GB/T 26572

表示该有害物质在该部件所有均质材料中的含量均在O-表示该有害物质在该部件所有均质材料中的含量均在GB/T 26572 规定的限量要求以下

X - The content of such a hazardous substance in a certain homogeneous material of such a component is above the limit required by GB/T 26572

X - 表示该有害物质至少在该部件的某一均质材料中的含量超出GB/T 26572 规定的限量要求

Component Name 部件名称	
Hex Stand-offs 六角隔撑	
Screw Locks 螺丝锁定	
Fibre receptacle cap 光纤头保护帽	
Key Switch 钥匙开关	
Optical Fibre 光纤	