

# Marana-X

The Fastest sCMOS Camera for  
Direct EUV and Soft X-ray Detection

## Key Specifications

- ✓ High Resolution: 4.2 Megapixel
- ✓ High Sensitivity: Up to 99% QE
- ✓ Fast Speeds: Up to 74 fps
- ✓ High Dynamic Range: Up to 16-bit
- ✓ EMP Resistant: CoaXPress data interface
- ✓ Deep Cooled: -45°C cooling
- ✓ No mechanical shutter required

## Key Applications

- ✓ *In situ* Radiography
- ✓ Tomography
- ✓ Spectroscopy
- ✓ Hyperspectral Imaging
- ✓ HHG Source Characterisation
- ✓ EUV Ptychography
- ✓ EUV Lithography

NEW  
MARANA-X-11  
MODEL



# Introducing Marana-X

## The Most Sensitive Back-illuminated sCMOS

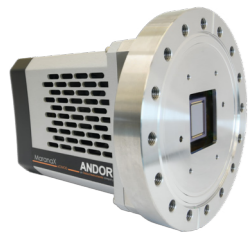

**Marana-X** is Andor's groundbreaking sCMOS platform tailored to direct EUV and soft X-ray applications. Hand crafted to deliver market leading performance and versatility Marana-X reads out a 4.2 Megapixel high resolution array in less than 50 milliseconds while maintaining very low read noise; hundreds of times faster than similar resolution CCD detectors.

### Marana 2k x 2k sCMOS - 'low noise readout'

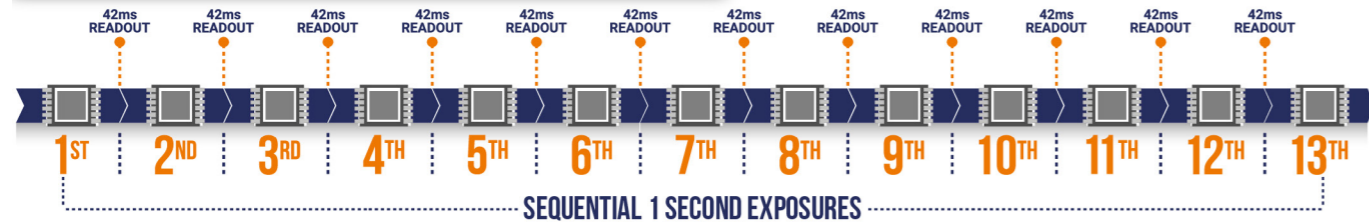

### 2k x 2k CCD (4 output ports) - 'low noise readout'



The **Marana-X-11** is the detector of choice when a large field of view with high sensitivity is required. Andor's unique glow suppression approach enables you to usefully and uniquely access the entire 2048 x 2048 11  $\mu$ m pixel array of the GSense 400 BSI Pulsar sensor, offering an impressive 32 mm sensor diagonal. Marana-X-11 presents an exclusive solution for capturing a large field of view across a wide range of exposure conditions, from microseconds up to several seconds.

The **Marana-X-6** is the sensor of choice when rapid frame rates and high sensitivity is required. Featuring 2048 x 2048 6.5  $\mu$ m pixel array the camera can access frame rates of up to 74 fps and single line spectroscopic scans of up to 25,253 fps. The Marana-X-6 extracts the very best of the GSense 2020 BSI Pulsar sensor offering unparalleled low noise, sensitivity, cooling, speed, and dynamic range.

# Features and Benefits

From soft X-ray tomography to hyperspectral imaging the Marana-X combines the sensitivity, speed, resolution and field of view to take on the most demanding imaging or spectroscopic challenges.

Feature	Benefit <sup>1</sup>
Up to 99% QE & lowest noise	Maximum signal to noise for light starved measurements. Achieve high contrast faster.
Vacuum cooled to -45°C	Very weak signals require lowest noise floor and longer exposures: Don't be restricted by camera thermal noise!
4.2 Megapixel	High pixel resolution, maintaining image clarity over an extended field of view.
The <b>ONLY</b> uncoated back-illuminated sCMOS	The Marana-X incorporated the world's first uncoated back-illuminated sCMOS sensor enabling unparalleled EUV – soft X-ray detection.
Extended Dynamic Range (EDR) Mode	'One snap quantification' across the full dynamic range, capture high and low intensity images in the same image.
> 99.7% linearity	Market leading quantitative accuracy over the whole signal range.
Fan and liquid cooling as standard	Liquid cooling for maximum sensitivity.
USB 3.0 and CoaXPRESS connectivity options	USB 3.0 provides flexibility. CoaXPRESS enables the highest speeds to capture the most dynamic events, and EMP resistant data transfer.
On-head asymmetric binning and multi-track	On-board intelligence delivering spectroscopists-friendly spectra and multi-track data prior to transfer through CoaXPRESS or USB interface. Upfront data size reduction and easier user data processing.
Selectable bit-depth up to 32-bit	Preserve dynamic range in extensive on-head binning scenarios. User-selectable data bit depth to be transmitted over the camera interface, up to 32-bit.
Marana-X-6 <sup>1</sup>	
6.5 $\mu$ m pixels	Smaller pixels better suited to some optical systems.
Low Noise Mode	Further reduces read noise floor at expense of pixel well depth, while maintaining a fast frame rate. Ideal when highest possible sensitivity is a priority.
High Speed Mode	Acquire images at high speeds of up to 74 fps in full frame 16-bit mode via CoaXPRESS! Boost speeds even further using regions of interest.
NEW Marana-X-11 <sup>1</sup>	
11 $\mu$ m pixels and 32 mm sensor diagonal	Large field of view sCMOS ideal for large area imaging and signal collection.
Anti-Glow Technology	Suppresses the effects of sensor amplifier glow, allowing access to the full 4.2 Megapixel array.

# Key Features

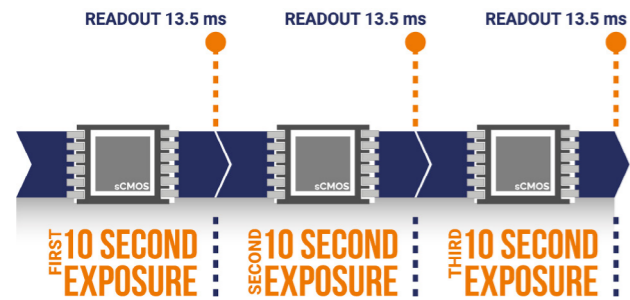

## Fast Sensor Readout

Taking only 13.5 milliseconds (X-6, 74 fps) or 42 milliseconds (X-11, 24 fps) per 16-bit full frame readout, both Marana-X models are ideal for the acquisition of large imaging data sets such as tomography, in-situ transient phenomena imaging and matching the frame rate requirements of the latest generation of high repetition rate lasers.

## Unparalleled Quantum Efficiency

Our Marana-X models boast superior quantum efficiency in the EUV-1 keV energy range compared to existing CCDs. The excellent quantum efficiency of Marana-X complements its high-end sCMOS technology allowing the minimisation of experimental time and maximum data throughput with of up to, a rapid, 74 fps full frame on 6.5  $\mu\text{m}$  models. Additionally, the sensor quantum efficiency and lifetime of Marana-X has been fully characterised in a recent scientific publication by [Harada and coworkers](#).

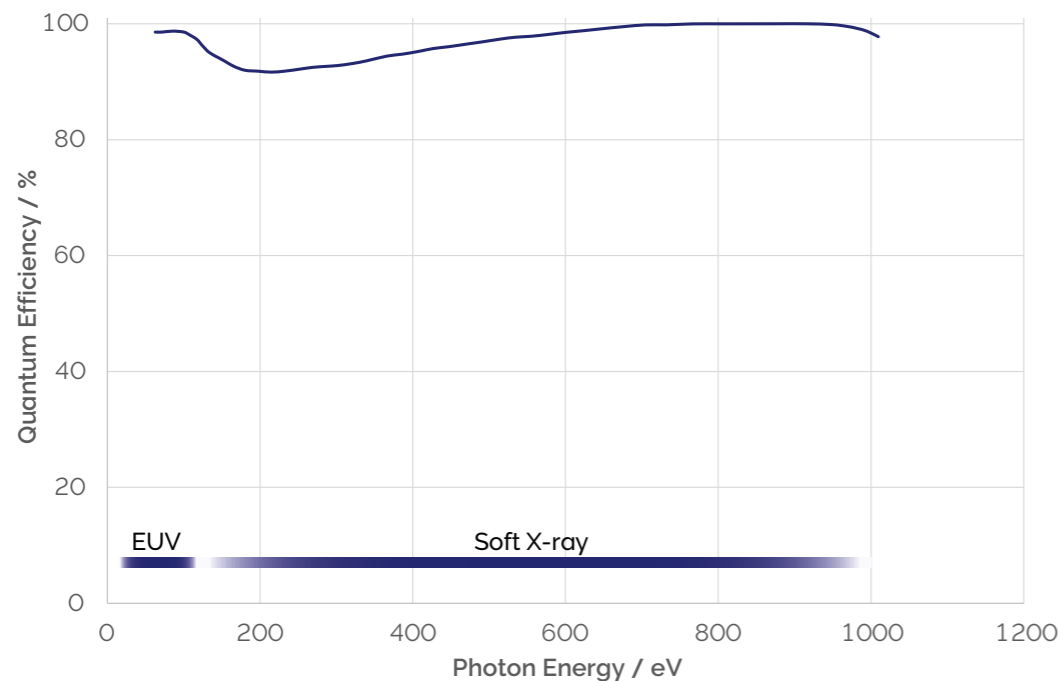

## Extended Dynamic Range

Large pixel well-depth and an on-chip multi-amplifier design means the whole photometric range, from the noise floor up to the saturation limit, can be captured within one image. The wide dynamic range is complemented by enhanced on-head intelligence to deliver linearity > 99.7%, for unparalleled quantitative accuracy of measurement across the full signal range.



## Low Noise

The uniquely optimised sensors of the Marana-X platform enable peak quantum efficiency in the EUV/ soft X-ray regime of >99%. The parallel readout architecture and innovative pixel design also drives exceptionally low read noise performance, <2  $e^-$ , whilst still achieving maximum readout speed and full dynamic range. Marana-X-6 additionally offers a further low noise mode to achieve 1.2  $e^-$  noise at reduced pixel well depth – ideal for extremely low flux applications.

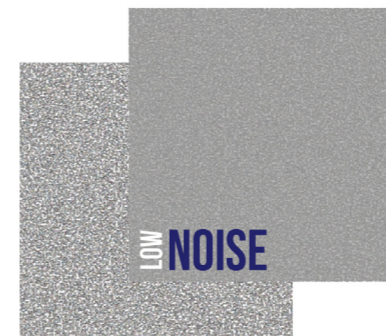

## No Mechanical Shutter

Applications that involve frequent cycling of mechanical shutters such as X-ray tomography, require routine shutter replacements and associated down time. The Marana-X platform offers on-sensor Rolling Shutter thus overcomes the need for mechanical shutters. Furthermore, this avoids the exposure gradient effects associated with that of an iris shutter.

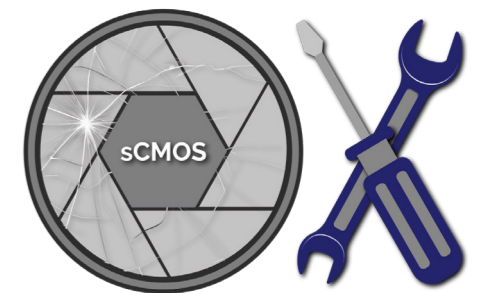

# Application Focus

## Soft X-ray Water Window Tomography

Soft X-ray microscopy in the water window (~285-535 eV) enables the unique imaging of intact cellular samples in their near-native state to resolutions of only a few 10 s of nm in detail. The excellent speed of the Marana-X-6 combined with unparalleled quantum efficiency in the 285-535 eV energy range makes the Marana-X-6 the ideal camera for water window tomography. This coupled with low read noise, large field of view and lack of mechanical shutter enables Marana-X-6 to collect high contrast data sets with minimal experimental downtime.

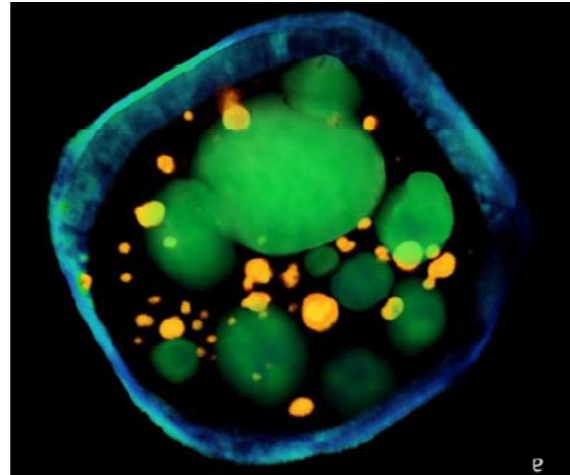

Fogelqvist, E., Kördel, M., Carannante, V. et al. Laboratory cryo x-ray microscopy for 3D cell imaging. Sci Rep 7, 13433 (2017). <https://doi.org/10.1038/s41598-017-13538-2>

## Soft X-ray Absorption Spectroscopy

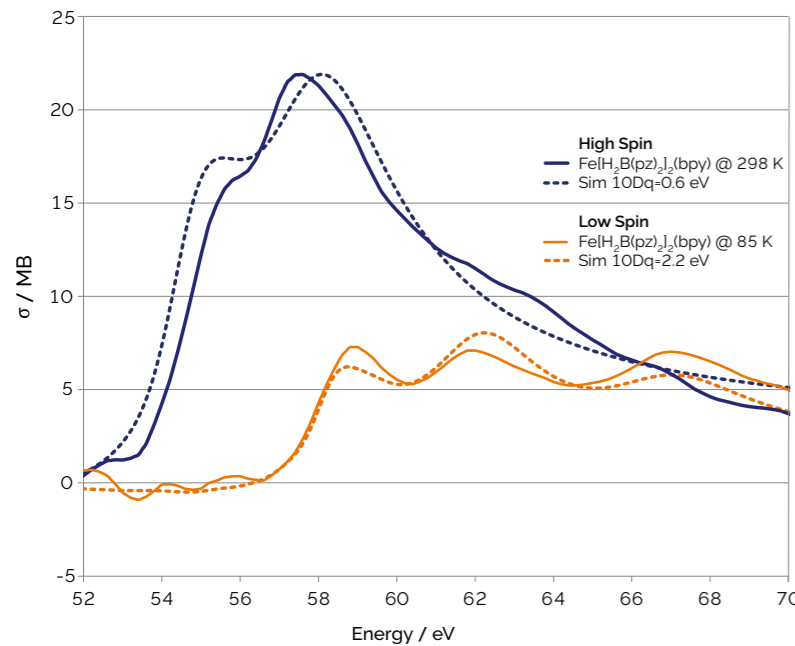

X-ray absorption near edge structure (XANES) is a powerful tool in the investigation of inner shell excitation. The unparalleled quantum efficiency in the soft X-ray regime of Marana-X makes it ideal for high harmonic generated femtosecond XANES experiments. The high frame rate of the Marana-X-6 also enables it to match modern high repetition rate pulses frame for frame, maximising data collection and minimising experimental downtime.

Left: data from Kaili Zhang, Ryan Ash, Gregory S. Girolami, and Josh Vura-Weis, Journal of the American Chemical Society 2019 141 (43), 17180-17188, DOI: 10.1021/jacs.9b07332

## Hyperspectral

Marana-X is ideal for fast, high dynamic range spectral imaging, either: (a) hyperspectral configurations (push-broom or otherwise), enabling full data cubes to be rapidly acquired, or (b) high density multi-track spectroscopy at fast spectral rates and/or very high dynamic range through image stacking.

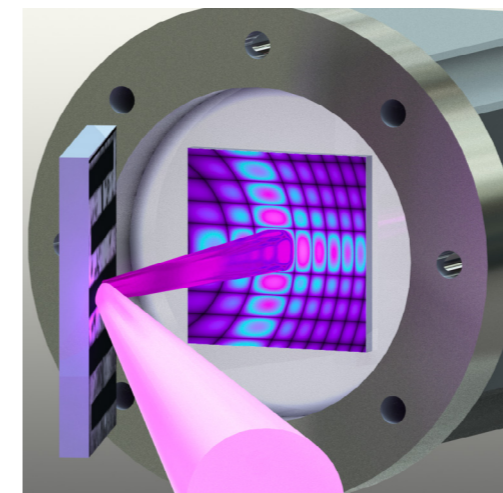
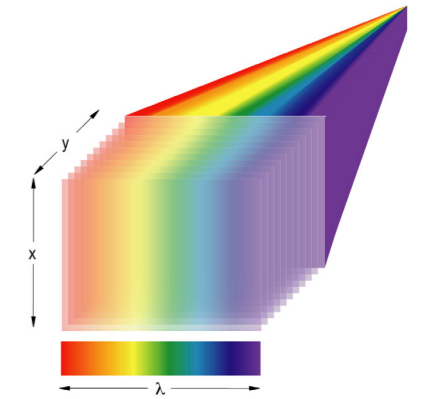

Image courtesy of Kapteyn-Murnane group, JILA

## Coherent Diffractive Imaging

Coherent diffractive imaging is a versatile phase-contrast microscopy technique that enables the 2D or 3D high fidelity reconstruction of nanoscale structures. Classically slow scan CCDs have been used to capture diffracted X-rays to build large 3D datasets, The Marana-X platform offers a step change in CDI with frame rates up to 74 fps. Marana-X is able to make the most of modern high flux X-ray sources and is able to operate in a 100% duty cycle mode enabling parallel sensor readout and exposure for 100% sensor detection time.

# Technical Specifications<sup>1</sup>

Model	Marana-X-11	Marana-X-6
Sensor Type	Back-Illuminated Scientific CMOS	
Array Size	2048 (W) x 2048 (H) 4.2 Megapixel	
Pixel Size	11 x 11 $\mu\text{m}$	6.5 x 6.5 $\mu\text{m}$
Image Area	22.5 mm x 22.5 mm (31.9 mm diagonal)	13.3 mm x 13.3 mm (18.8 mm diagonal)
Readout Modes	Rolling Shutter	
Pixel Readout Rates	100 MHz (High Dynamic Range mode, 16-bit) 200 MHz (Fast Speed mode, 12-bit)	310 MHz (Fast High Dynamic Range mode, 16-bit) 180 MHz (Low Noise mode, 12-bit)
Quantum Efficiency <sup>2</sup>	up to 99%	
Read Noise (e <sup>-</sup> ) median <sup>3</sup>	1.6 e <sup>-</sup> (at any readout rate)	1.6 e <sup>-</sup> (Fast High Dynamic Range mode, 16-bit) 1.2 e <sup>-</sup> (Low Noise mode, 12-bit)
Sensor operating temperature <sup>4</sup> Air cooled Water/liquid cooled	-25°C (up to 30°C ambient) -45°C (@16°C water)	
Dark Current Air cooled (@-25°C) Water/liquid cooled (@ -45°C)	0.7 e <sup>-</sup> /pixel/s 0.3 e <sup>-</sup> /pixel/s	0.15 e <sup>-</sup> /pixel/s 0.10 e <sup>-</sup> /pixel/s
Active area pixel well depth	85 000 e <sup>-</sup> (High Dynamic Range mode, 16-bit) 2600 e <sup>-</sup> (Fast Speed mode, 12-bit, bit depth limited)	55 000 e <sup>-</sup> (Fast High Dynamic Range mode, 16-bit) 1800 e <sup>-</sup> (Low Noise mode, 12-bit, bit depth limited)
Dynamic Range	53 000:1 (High Dynamic Range mode, 16-bit)	34 000:1 (Fast High Dynamic Range mode, 16-bit)
Data Range	16-bit (High Dynamic Range mode) 12-bit (Fast Speed mode)	16-bit (Fast High Dynamic Range mode) 12-bit (Low Noise mode)
Linearity <sup>5</sup>	> 99.7%	
PRNU	< 0.5% (@ half-light range)	
Region of Interest (ROI)	User-definable, 1 pixel granularity, min. size 25 (w) x 1 (h)	User-definable, 1 pixel granularity, min. size 9 (w) x 1 (h)
Pixel Binning (on FPGA)	User-definable down to 1 pixel granularity in horizontal and vertical.	
Vacuum Compatibility	Recommended use at vacuum between 10 <sup>-4</sup> and 10 <sup>-8</sup> Millibar	

Model	Marana-X-11	Marana-X-6
I/O	O: Fire Row 1, Fire Row n, Fire All, Fire Any, Arm I: External	
Trigger Modes	Internal, External, External Start, External Exposure, Software	
Software Exposure Events <sup>6</sup>	Start exposure - End exposure (row 1), Start exposure - End exposure (row n)	
Image Timestamp Accuracy	25 ns	
PC Interface	USB 3.0 <sup>7</sup> and CoaXPress	
Mounting Flange	DN100CF (ConFlat) 6" O.D. fixed flange available with M8 or 5/16 UNC threaded holes	

## Flexible Connectivity

- 1 USB 3.0<sup>7</sup>  
A convenient, universally available high-speed interface.
- 2 TTL / Logic  
Connector type: 15-way D-type to BNC cable with AUX\_OUT\_1 (Output), External Trigger (Input), ARM (Output).
- 3 CoaXPress  
CoaXPress (2 lane) offers the highest speed data interface
- W Water Cooling  
Connection to recirculator or other water/liquid cooling system is possible for maximum sensitivity.
- P Power  
Connection to PSU refer to power requirements on page 12.

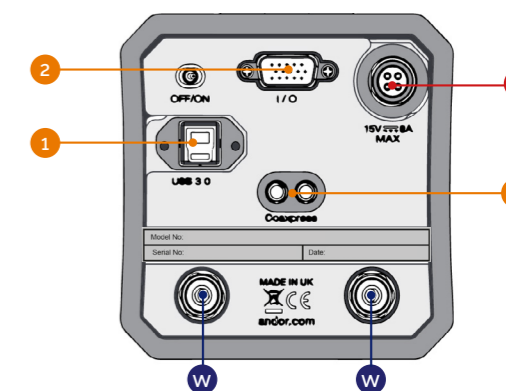

Notes: Minimum cable clearance required at rear of camera: 100 mm.

## Have you found what you are looking for?

**Need a larger field of view?** [iKon-XL CCD](#) offers a 16.8 Megapixel sensor with 15  $\mu\text{m}$  pixel pitch offering up to 350 ke<sup>-</sup> well depths, 18 bit dynamic range and - 80°C deep cooling.

**Need faster frame rates?** The [Zyla-HF](#) fibre coupled to scintillator sCMOS platform can deliver 100 fps from a full 5.5 or 4.2 Megapixel array, faster still with sub-array selection.

**Looking at hard X-rays or Neutrons?** The [Balor-X sCMOS](#) offers a market leading 16.9 Megapixel sensor combined with rapid 54 fps full frame readout, high dynamic range and low noise readout ideal for lens coupled experimental setups.

# Different Modes for Marana-X

## Multi-track Mode

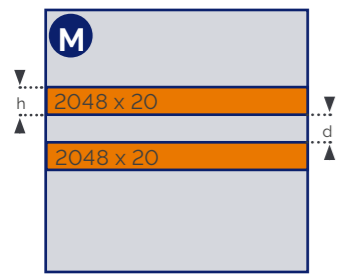

Up to 256 vertically binned tracks can be used for multi-track analysis without sacrificing speed.

## Imaging Mode

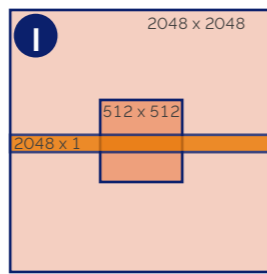

The array size may be defined for either resolution or maximum speed.

## Spectroscopy Mode

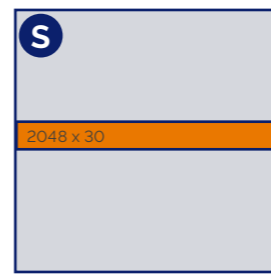

A vertically binned track is centred on the sensor enabling the maximum spectral rate to capture dynamic events.

## I Imaging Mode -11

Frame rate table

ROI Size (W x H)	Max Frame Rate (fps)		ROI area (of sensor)	Example scenarios of use	
	16-bit	12-bit			
2048x2048	24	48	22.5 mm x 22.5 mm	Full FOV imaging, Tomography & Ptychography	
2048x1200	41	81	22.5 mm x 13.2 mm		
1608x1608	30	61	17.7 mm x 17.7 mm		
1400x1400	35	70	15.4 mm x 15.4 mm		
1200x1200	41	81	13.2 mm x 13.2 mm		
1024x1024	48	95	11.3 mm x 11.3 mm		
512x512	95	190	5.6 mm x 5.6 mm		
256x256	190	378	2.8 mm x 2.8 mm	High density multitrack on Kymera/Shamrock	
128x128	378	750	1.4 mm x 1.4 mm		
2048x8	5,415	9,747	22.5 mm x 88 mm		
2048x2	16,244	24,367	22.5 mm x 22 mm		Fast spectroscopy & source monitoring
2048x1	24,367	24,367	22.5 mm x 11 mm		

## M Multi-track Mode -11

Vertically binned tracks (overlap ON)

Number of Tracks	Track height (h)		Track separation (d)		Max Acquisition Rate	
	Pixels	µm	Pixels	µm	16-bit	12-bit
2	10	110	10	110	2,321	4,430
2	10	110	0	0	2,321	4,430
2	20	220	10	110	1,189	2,321
6	50	550	40	440	162	323
10	10	110	0	0	483	956
10	20	220	0	0	242	483
10	30	330	30	330	162	323
50	20	220	0	0	49	97
60	20	220	0	0	41	81
100	20	220	0	0	24	49

## S Spectroscopy Mode -11

Vertically binned tracks (overlap ON)

Array Size (W x H)	Max Spectra Rate	
	16-bit	12-bit
any x 1	24,367	24,367
any x 2	16,244	24,367
any x 8	5,415	9,747
any x 1200	41	81
any x 2048	24	48

## S Spectroscopy Mode -6

Vertically binned tracks (overlap ON)

Array Size (W x H)	Max Spectra Rate	
	16-bit	12-bit
any x 1	25,253	14,881
any x 2	25,253	14,881
any x 8	15,152	8,929
any x 1200	126	74
any x 2048	74	44

## I Imaging Mode -6

Frame rate table

ROI Size (W x H)	Max Frame Rate (fps)				ROI area (of sensor)
	USB 3.0		CoaXPress		
	16-bit	12-bit	16-bit	12-bit	
2048x2048	40	43	74	44	13.3 mm x 13.3 mm
1400x1400	85	63	108	64	9.1 mm x 9.1 mm
1200x1200	116	74	126	74	7.8 mm x 7.8 mm
1024x1024	148	87	148	87	6.7 mm x 6.7 mm
512x512	295	174	295	174	3.3 mm x 3.3 mm
256x256	587	346	587	346	1.7 mm x 1.7 mm
128x128	1,165	686	1,166	687	0.8 mm x 0.8 mm

## M Multi-track Mode -6

Vertically binned tracks (overlap ON)

Number of Tracks	Track height (h)		Track separation (d)		Max Acquisition Rate	
	Pixels	µm	Pixels	µm	16-bit	12-bit
2	10	65	10	65	6,887	4,058
2	10	65	0	0	6,887	4,058
2	20	130	10	65	3,608	2,126
6	50	325	40	260	502	296
10	10	65	0	0	1,485	875
10	20	130	0	0	750	442
10	30	195	30	195	502	296
50	20	130	0	0	151	89
60	20	130	0	0	126	74
100	20	130	0	0	76	45

Note: Frame/spectral rates do not differ if partial or full rows are selected.

# Creating the Optimum Product for You

## Step 1. Choose the camera

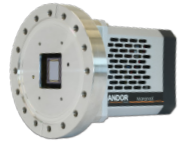

Marana-4BN: **U** - **SOI**  
example shown

Pixel Size	
Marana-X-6: 4.2 Megapixel Back-illuminated sCMOS EUV/soft X-ray optimised, 6.5 µm pixel, >99% QE	<b>6</b>
Marana-X-11: 4.2 Megapixel Back-illuminated sCMOS EUV/soft X-ray optimised, 11 µm pixel, >99% QE	<b>1</b>
Connectivity	
USB connectivity (43 fps max)	<b>U</b>
USB & CoaXPress connectivity (74 fps max)	<b>X</b>
Flange Connector	
6" flange with 5/16 UNC threaded holes	<b>SOI</b>
6" flange with M8 threaded holes	<b>SOM</b>

## Step 2. Select the required accessories

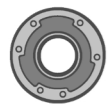

Accessories

Description	Order Code
Re-circulator for enhanced cooling performance (supplied with 2x2.5 m tubing as standard)	<b>XW-RECR</b>
Oasis 160 Ultra compact chiller unit (tubing to be ordered separately)	<b>ACC-XW-CHIL-160</b>
6 mm tubing options for Oasis 160 Ultra compact chiller (2x2.5 m or 2x5 m lengths)	<b>ACC-6MM-TUBING-2X2.5</b> <b>ACC-6MM-TUBING-2X5M</b>
Pair of barbed hose inserts for 6 mm tubing	<b>6MM-HOSE-BARBS</b>
Beryllium filter for Marana-X (250 µm thick)	<b>ACC-OPT-03838</b>
Optional filter holder for Marana-X	<b>SO-FILTER-MNT-IKONL</b>
CoaXPress cables: 30 m cables (set of 2x individual cables supplied)	<b>ACC-COAXP-CABLE-2020</b>

**CSR** Other flange options are available through our Customer Special Request process - please contact your sales representative.

## Step 3. Select the required software



### Software

Marana-X requires one of the following software options:

#### Solis Imaging

A 32-bit and fully 64-bit enabled application for Windows (8.1 and 10) offering rich functionality for data acquisition and processing. AndorBasic provides macro language control of data acquisition, processing, display and export.

#### Andor SDK3

A software development kit that allows you to control Andor sCMOS cameras from your own application. Available as a 32-bit or 64-bit library for Windows (8.1 and 10) and Linux. Compatible with C/C++, LabVIEW, MATLAB and Python.

#### GPU Express

Andor GPU Express library has been created to simplify and optimize data transfers from camera to a CUDA-enabled Nvidia Graphical Processing Unit (GPU) card to facilitate accelerated GPU processing as part of the acquisition pipeline. Integrates easily with Andor SDK3 for Windows.

Third party software compatibility Drivers are available for a variety of third party imaging packages. See Andor website for detail: [andor.oxinst.com/third-party-software-matrix](http://andor.oxinst.com/third-party-software-matrix)

## Marana-X Purchase Flexibility

Don't want to commit to CoaXPress connectivity from the outset? If preferred, order the less expensive USB 3.0-only version and later avail of a simple in-field upgrade to CoaXPress capability, using the **CHAM-UPG-CXP** code, if and when additional speed is needed. The upgrade includes CoaXPress card, cable and remote session to upgrade camera firmware and unlock CoaXPress capability. Please contact your sales representative for more information.

## Best Practice Guidelines

### Condensation

- It is strongly advised that the camera should not be used in a condensing atmosphere.
- If used in a condensing atmosphere the sensor **MUST** be protected and the use of a cold finger is strongly recommended.

### Contamination & Damage

- When not in use, the sensor chamber should be covered and sealed.
- Due to the exposed nature of the sensor, extreme care should be taken with the camera, as damage can easily occur through mishandling or by contamination.
- If the sensor becomes contaminated, due to accident or misuse, please contact Andor immediately for advice on cleaning.

### Vacuum Operations

- Ensure that the vacuum environment to which the camera is fitted is free of water vapour and other contaminants.
- Care should also be taken to control pressure change, as sudden pressure changes can potentially cause damage to the sensor assembly.

# Mechanical Drawings

Dimensions in mm [inches]

Weight (approx): -5.4 kg

**Marana-X-6** M8x1.25  $\nabla$  16.0[0.630] - METRIC VARIANTS  
5/16-24 UNF  $\nabla$  16.0[0.630] - IMPERIAL VARIANTS  
16 OFF - EQUALLY SPACED ON PCD  $\phi$ 130.25 [5.128]

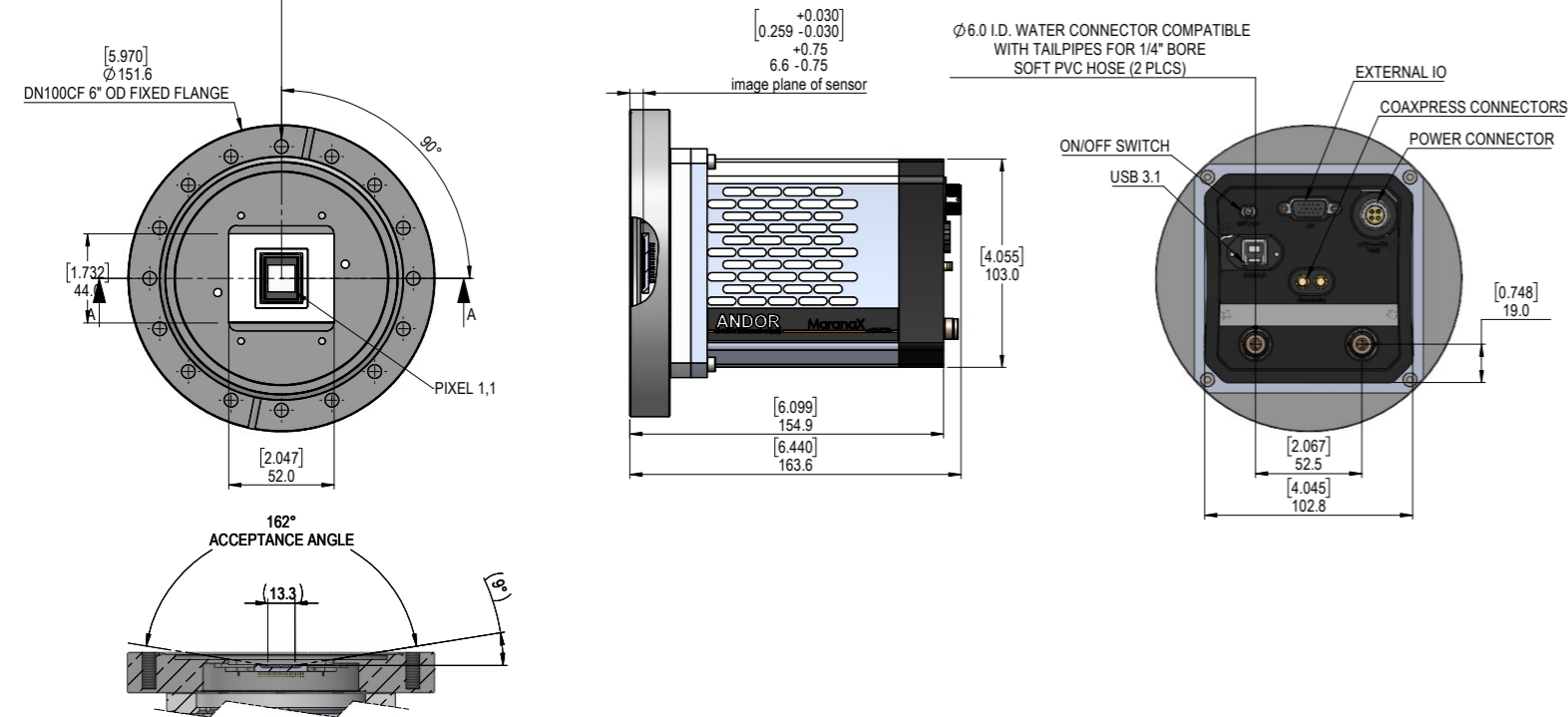

**Marana-X-11** M8x1.25  $\nabla$  16.0[0.630] - METRIC VARIANTS  
5/16-24 UNF  $\nabla$  16.0[0.630] - IMPERIAL VARIANTS  
16 OFF - EQUALLY SPACED ON PCD  $\phi$ 130.25 [5.128]

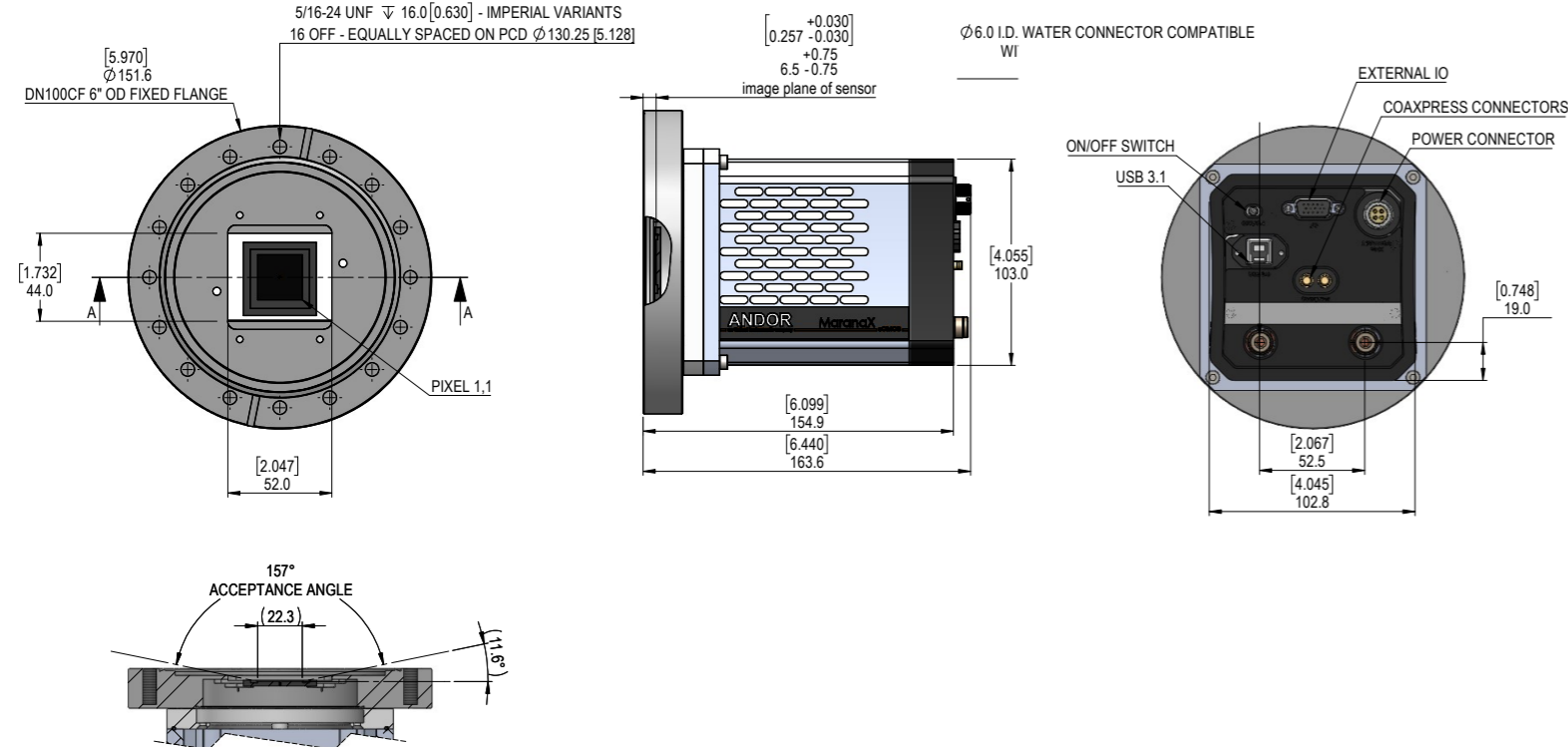

## Our Cameras for High Energy Detection

Andor's portfolio of CCD, sCMOS and EMCCD cameras provide a wide range of high sensitivity, high dynamic range and fast detection solutions for table-top laboratory and beamline experiments. These detectors benefit especially applications in the field of EUV, X-ray, neutron or electron detection for material science, plasma studies, bio-samples analysis or beam/source characterisation.

### Open fronted direct X-ray detection cameras



- ✓ Long exposure
- ✓ Deep cooling
- ✓ Direct detection
- ✓ Large pixel well depths
- ✓ Imaging and spectroscopy

iKon & Newton CCD & Marana-X SO ranges

### Beryllium windowed direct soft X-ray detection cameras

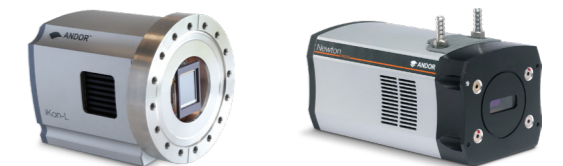

- ✓ Long exposure
- ✓ Direct detection
- ✓ Permanent vacuum
- ✓ Imaging and spectroscopy

iKon CCD, Newton CCD & iVac CCD SY ranges

### Fibre-optic coupling hard X-ray detection cameras

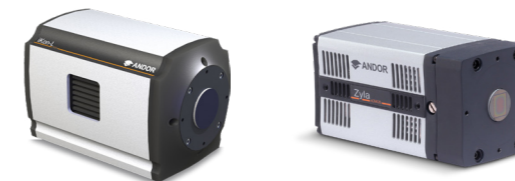

- ✓ Fast
- ✓ Low noise
- ✓ High throughput
- ✓ Modular scintillator options

Zyla-HF sCMOS & iKon-L-HF CCD cameras

### Windowed lens coupled hard X-ray & neutron detection cameras



- ✓ Fast
- ✓ Low noise
- ✓ Large area
- ✓ Deep cooled

iKon CCDs, Balar sCMOS, Zyla sCMOS, Neo sCMOS, Marana sCMOS, iXon EMCCDs

Learn more about our detector range [here](#).



# Order Today

Need more information? At Andor we are committed to finding the correct solution for you. With a dedicated team of technical advisors, we are able to offer you one-to-one guidance and technical support on all Andor products.

For a full listing of our local sales offices, please see: [andor.oxinst.com/contact](http://andor.oxinst.com/contact)

Our regional headquarters are:

## Europe

Belfast, Northern Ireland  
Phone +44 (28) 9023 7126  
Fax +44 (28) 9031 0792

## Japan

Tokyo  
Phone +81 (3) 6732 8968  
Fax +81 (3) 6732 8939

## North America

Concord, MA, USA  
Phone +1 (860) 290 9211  
Fax +1 (860) 290 9566

## China

Beijing  
Phone +86 (10) 5884 7900  
Fax +86 (10) 5884 7901

### Items shipped with your camera

1x USB 3.0 PCIe card\*7  
1x USB 3.0 Cable (3 m)\*7  
1x Multi I/O Timing Cable (BNC to D-type: 1.5 m)  
1x 15 V PSU  
1x Country specific power cord  
1x User manuals in electronic format  
1x Quickstart Guide  
1x Individual system performance booklet  
Marana-X 4.2B-6 with CoaXPress also includes:  
1x CoaXPress 3.0 PCIe card with external trigger  
1x CoaXPress Cable (3 m)  
1x Single I/O Timing Cable (BNC to SMB: 1.5 m)

### Minimum Computer Requirements:

- 3.0 GHz single core or 2.4 GHz dual or quad core processor
- 8 GB RAM
- Hard drive: 850 MB/sec write speed recommended for the data rate associated with the max. frame rates. 250 MB free hard disc to install software
- USB 3.0 slot (or x4 PCIe slot for USB 3.0 card)
- x8 PCIe slot for CXP PCIe card
- Windows (8.1 and 10) or Linux

### Footnotes

1. Figures are typical and target specifications and therefore subject to change.
2. Quantum efficiency as supplied by the sensor manufacturer.
3. Read noise measured at 0°C (Marana-X 4.2B-6).
4. Coolant temperature must be above dew point.
5. Linearity is measured from a plot of Signal vs. Exposure Time over the full dynamic range.
6. Software Exposure Events provide rapid software notification (SDK only) of the start and end of acquisition.
7. Marana-X connects to your control PC using a USB 3.0 connection. This may also be referred to as USB 3.1 (Gen 1). Andor provide a USB 3.0 card and cable, and recommend that these are used to ensure optimum performance.

### Operating & Storage Conditions:

- Operating Temperature: 0°C to +30°C ambient
- Operating Altitude: up to 6000 m
- Relative Humidity: <70% (non-condensing)
- Storage Temperature: -10°C to 50°C

### Power Requirements:

- 100 - 240 VAC, 50 - 60 Hz
- Power consumption: 40 - 46 W typical / 114 W max (model dependent)



Windows is a registered trademark of Microsoft Corporation.  
Labview is a registered trademark of National Instruments.  
Matlab is a registered trademark of The MathWorks Inc.